



## BOLTING TECHNOLOGY

[www.cmco.eu](http://www.cmco.eu)

## The brands

# Yale®

Yale is the leading brand for standard manual hoisting equipment in Europe. As early as 1877, Yale produced the first spur-gear hand chain hoist incorporating the Weston screw-and-disc type load brake – a design principle which is still used today. In 1936, hoist manufacture started in Velbert with the production of the world renowned PUL-LIFT®.

The product range as well as all new and further developments of Yale in the individual product sectors constantly raise the benchmark for quality, reliability and safety.

The comprehensive range of products includes hoists, cranes, load hoisting tackles and crane weighers, balancers, textile lifting and lashing equipment and personal protection equipment, material handling equipment and load moving systems, hydraulic tools, bolting technology as well as workshop equipment. The prominently yellow products, which are delivered ready for operation, are used world-wide for the most varied industrial and commercial applications.



# PF AFF

silberblau

Pfaff-silberblau – the name of this company with its long-standing tradition and history of more than 140 years has become the synonym for power, dynamics and safety. Hoists, material handling equipment as well as rope winches and rack and pinion jacks of the Pfaff-silberblau brand are used wherever high loads need to be lifted, turned or moved in an environment with demanding safety requirements.

In logistics, industrial production or outdoor applications, the innovative products and application-specific designs with their unique silver blue finish provide the solution to numerous lifting applications.



## The company

### COLUMBUS McKINNON Industrial Products GmbH

Yale has already been a successful partner within the international corporate network of Columbus McKinnon Corporation (CMCO) for more than ten years.

Since 2008, Pfaff-silberblau has extended the portfolio of products and services of the company.

Today, the two trademarks of Yale and Pfaff-silberblau are combined under the name of Columbus McKinnon Industrial Products GmbH. As partners, we present a comprehensive range of products whereby each individual product fulfills the wide variety of our customers' requirements with regards to performance, quality and efficiency. Experience, know-how and innovative strength combined with a far-reaching understanding of user requirements is the formula for success on which our portfolio of hoisting and material handling equipment products has been based for a long time. Our tradition of close customer relationships and customer services as well as our constant striving for optimisation provide the basis for all new and further developments of the Yale and Pfaff-silberblau brands.

As a premium supplier of two leading brands, we have set ourselves the target of offering our customers world-wide high-quality hoisting and material handling equipment that is designed for moving, lifting, positioning and securing heavy loads both ergonomically and safely.

Columbus McKinnon Industrial Products GmbH is a subsidiary of Columbus McKinnon Corporation (CMCO), Amherst/USA, one of the world's leading providers of material handling equipment. CMCO has more than 130 years experience in developing and producing cranes, hoists and lifting tackles. Today, the company has more than 2500 employees world-wide.

More information about Columbus McKinnon Industrial Products as well as the brands Yale and Pfaff-silberblau is available on the Internet at [www.cmco.eu](http://www.cmco.eu), [www.yale.de](http://www.yale.de) and [www.pfaff-silberblau.com](http://www.pfaff-silberblau.com)





## Training

We offer many different training seminars in our training centres in Velbert and Kissing. The centres offers not only product training but also seminars providing up-to-date insider information and a consolidated knowledge in the usage of rope, lifting and lashing practices. Modern communication technologies, hands-on experience and well designed training documentation guarantee a quick and lasting training success. As required all training seminars can also be held at other locations. Seminars on special themes on request.



## Training

- to become a "competent person" for the inspection of Yale and Pfaff-silberblau hoisting equipment according to UVV BGV D8
- becoming a competent person due to EN 365 to inspect PPE against fall from height yearly
- annually high rescue training and instruction in using PPE against fall and rescue systems correctly

## Target group

Members from all industrial areas

- who are entrusted with the inspection, service and repair of hoisting equipment.
- who are entrusted with the use and inspection of PPE

## Our service for you:

Qualified personnel as well as specialised dealers provide competent know-how and service. Columbus McKinnon logistics with worldwide distribution allows short lead times and international availability.

### Business hours:

Monday - Thursday 08:00 a.m - 04:30 p.m

Friday 08:00 a.m - 03:30 p.m

### Shipping:

Monday - Thursday 07:00 a.m - 12:00 a.m and

12:30 p.m - 04:00 p.m

Friday 07:00 a.m - 02:00 p.m

## Product documentation

Every unit is supplied with operating instructions, CE declaration of conformity resp. manufactures works test certificate, which confirms the perfect tested status of the product.

Additional documentation, e.g. spare parts manuals or maintenance and repair instructions are available on request or at our homepage

[www.cmco.eu](http://www.cmco.eu)



## DIN EN ISO 9001

Columbus McKinnon Industrial Products GmbH manufactures world wide according to uniform, controlled standards of EN ISO 9001.

This is a guarantee for our business partners that given standards in design and development, manufacturing, assembly and service are complied with.



Certified since November 1991



## Special Documentation

Additional inspections with test report 2.2 resp. inspection certificate 3.1.B according to EN 10204, GOST R certificates or specific pre-shipment inspections e.g. by DNV or GL can be carried out at cost on request.



Hydraulic torque wrenches



Lifting & spreading wedges



Hydraulic bolt tensioners



Torque multipliers



Pneumatic torque wrenches



Flange spreaders



Hand pumps model HPS



Foot pump model FPS



Mini hydraulic pumps model PAY

! Selection charts for suitable combinations of nut splitters/flange spreaders and hydraulic pumps can be found on page 39.

## Bolting Technology

Yale bolting technology is the general term of reliable and proven equipment renowned world-wide for controlled tightening or loosening of bolted connections.

The comprehensive range of products includes hydraulic torque wrenches for a maximum tightening torque of up to 78600 Nm, pneumatic torque wrenches for up to 4000 Nm as well as hydraulic bolt tensioners for a maximum thread dimension of M150. Hydraulic flange spreaders, hydraulic nut splitters and manual torque multipliers for up to 47000 Nm complement the portfolio.

Special features of these products are their long service life, easy and quick maintenance and repair.

All products from the bolting technology sector fulfil national and international regulations such as e.g. the EC Machinery Directive 2006/42/EC including corresponding supplements. It goes without saying that all torque wrenches are provided with a calibration certificate and operating instructions with a declaration of conformity or a manufacturer's declaration.

**We also provide re-calibrations for torque values up to 70000 Nm on request.**



Hydraulic nut splitters



Hydraulic flange spreaders



Backup wrench



Torque wrenches

## Table of Contents

	Page
Hydraulic torque wrenches	8 - 19
Pneumatic torque wrenches	20 - 21
Hydraulic nut splitters	22 - 23
Flange spreaders	24
Hydraulic lifting & spreading wedges	25 - 26
Torque multipliers	27 - 28
Torque wrenches	29 - 31
Hydraulic bolt tensioners	32 - 41
Hydraulic tools	42 - 46
Selection charts	44
Impact sockets	47 - 61



## Hydraulic torque wrench model YTS

For use with impact sockets

### Features

- Mono body housing, highest quality aircraft grade 7075 aluminium housing for unrivalled strength.
- „Push through“ square drive that easily pushes through to switch from loosen to tighten.
- Replaceable extensions for reaction arm allowing on site change over. Protects costly replacement of complete reaction arm when longer reach is needed.
- Long length reaction arm allows multi positioning. Allows taking reaction on most applications.
- Dual 360° swivel allows free 360° individual movement of duplex hoses for secure working conditions, also in confined spaces.
- Non-drip quick-connect couplers assure safe operation with ease for engaging and disengaging of hoses.
- Reaction arm release button, housed within the reaction arm, allows quick and safe positioning of reaction arm.
- Drive segment ensures that tool will never lock up.
- Direct housing reaction allows use without reaction arm



#### Drive plate

Single piece high strength alloy drive plate for maximum life. Allows small nose radius for the tool.

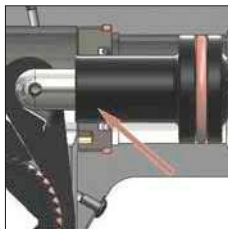

#### Piston assembly

Smooth leak proof functioning of enclosed alloy steel piston provides required torque. Uses a single seal for maximum maintenance free operation.

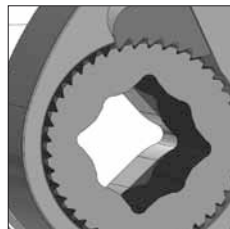

#### Multi tooth ratchet assembly

Highest strength teeth assures 28° torque stroke with greatest accuracy



#### Laser engraved torque chart

Laser engraved shroud for on the spot torque chart viewing.



#### Anti-backlash mechanism

Allows hands free working.



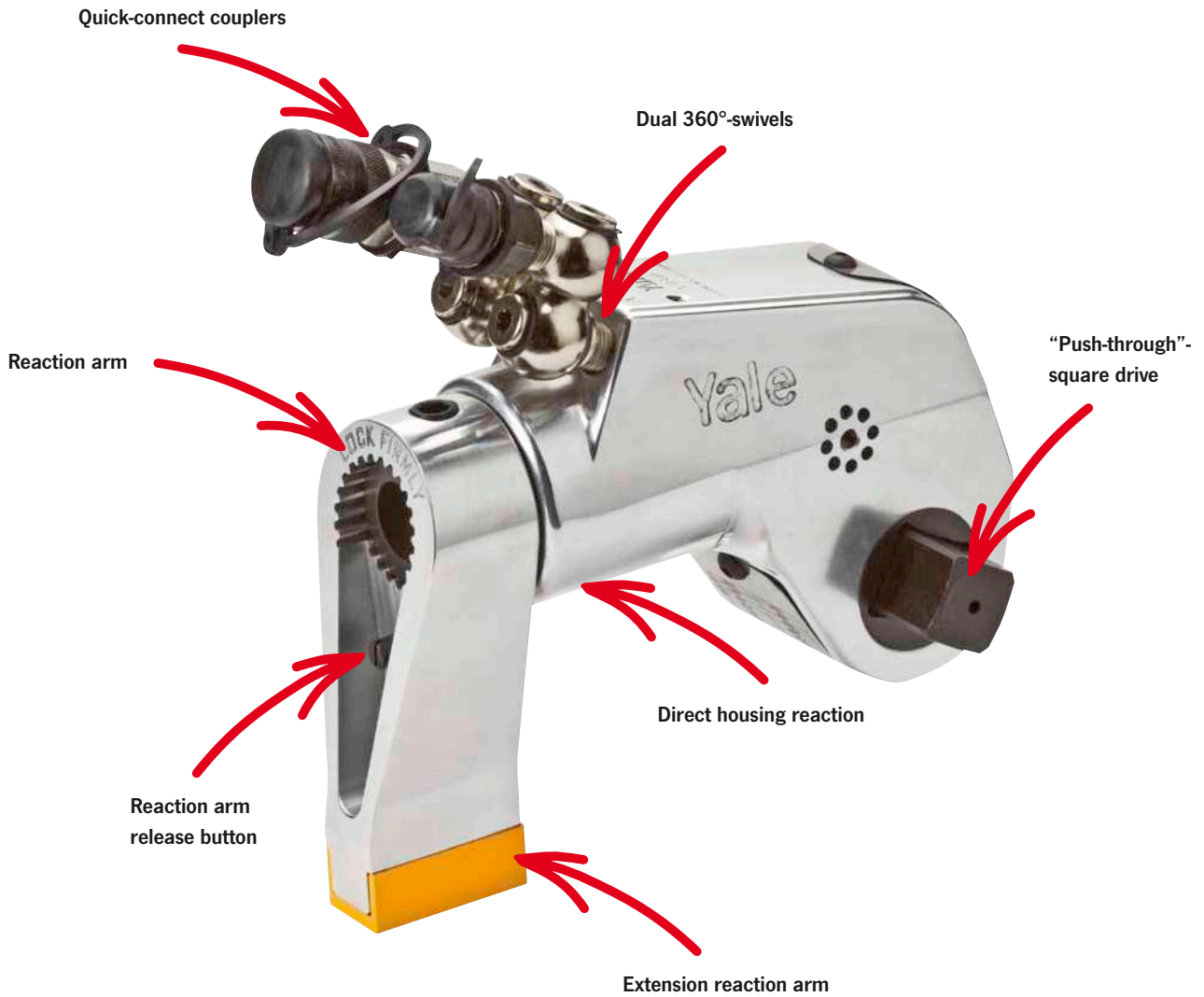

Technical data model YTS

Model	EAN-No. 4025092*	Square drive	Torque min. Nm	Torque max. Nm	Output accuracy	Repeatability	Weight kg
YTS-01	*472487	3/4"	172	1722	±3%	100%	1.9
YTS-02	*471909	1"	447	4515	±3%	100%	4.2
YTS-03	*471923	1 1/2"	1000	10034	±3%	100%	8.9
YTS-04	*471985	1 1/2"	1491	14929	±3%	100%	13.6
YTS-05	*472029	2 1/2"	3688	36883	±3%	100%	32.8
YTS-06	*472043	2 1/2"	7864	78648	±3%	100%	60.8

## Dimensions model YTS

Model	YTS-01		YTS-02		YTS-03		YTS-04		YTS-05		YTS-06	
	mm	inch	mm	inch	mm	inch	mm	inch	mm	inch	mm	inch
A	105	4.13	131	5.15	176	6.92	198	7.80	260	10.22	295	11.61
B	121	4.76	157	6.18	205	8.07	240	9.44	318	12.53	393	15.48
C	160	6.29	208	8.17	276	10.86	313	12.33	416	16.36	521	20.51
D	25	0.98	33	1.30	43	1.70	50	1.95	62	2.43	74	2.90
E	51	2.01	69	2.70	94	3.68	100	3.93	134	5.26	168	6.60
F	72	2.81	95	3.72	130	5.13	139	5.47	198	7.79	227	8.93
G	108	4.25	149	5.85	202	7.95	223	8.75	297	11.70	370	14.56

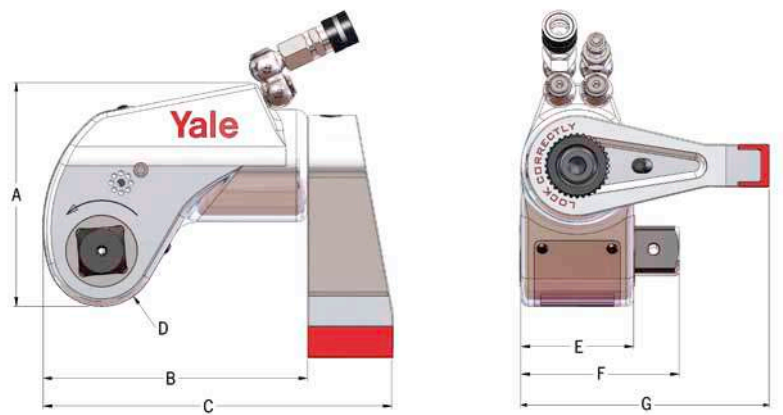

## Accessories for model YTS

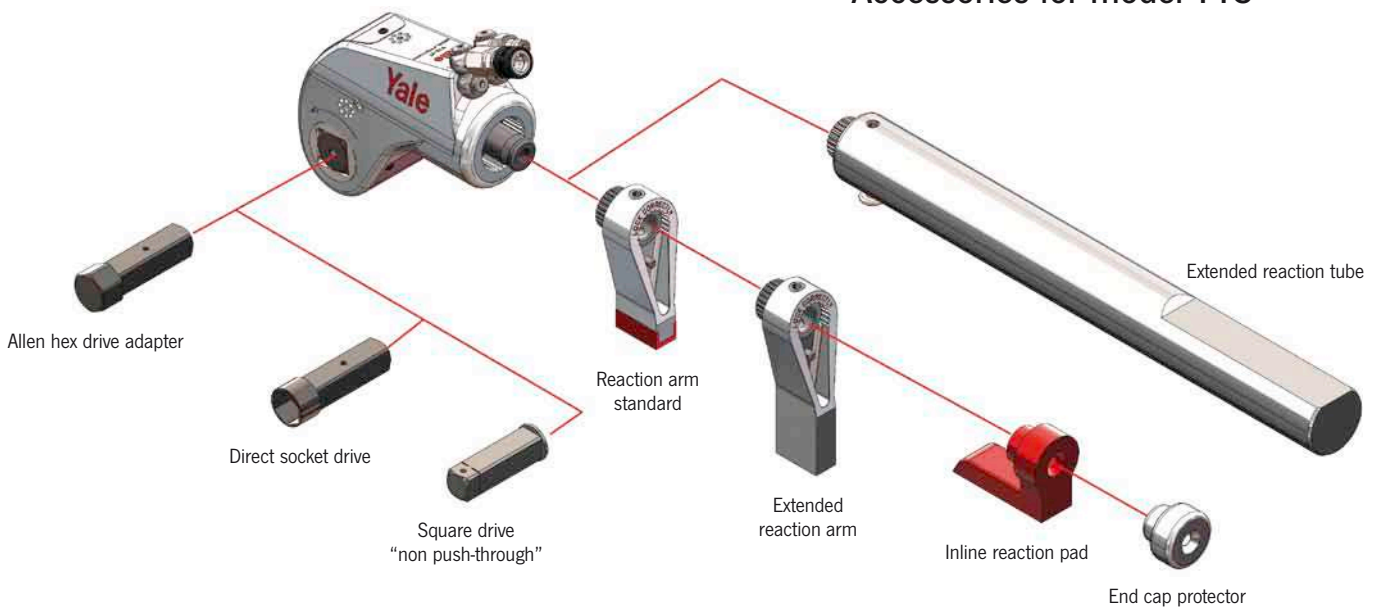

Technical data YTS extensions for reaction arm

Model	EAN-No. 4025092*	for model	Length L	
			mm	inch
YTS-01-EXT-1	*485067	YTS-01	25.4	1
YTS-01-EXT-2	*485074	YTS-01	50.8	2
YTS-01-EXT-3	*485081	YTS-01	76.2	3
YTS-02-EXT-1	*485098	YTS-02	25.4	1
YTS-02-EXT-2	*485104	YTS-02	50.8	2
YTS-02-EXT-3	*485128	YTS-02	76.2	3
YTS-03-EXT-1	*485142	YTS-03	25.4	1
YTS-03-EXT-2	*485159	YTS-03	50.8	2
YTS-03-EXT-1	*485166	YTS-03	76.2	3
YTS-04-EXT-1	*485173	YTS-04	25.4	1
YTS-04-EXT-2	*485180	YTS-04	50.8	2
YTS-04-EXT-3	*485197	YTS-04	76.2	3
YTS-05-EXT-1	*485203	YTS-05	25.4	1

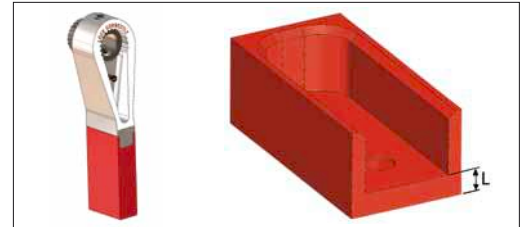

Extensions for reaction arm

Technical data YTS inline reaction pad

Model	Art.-No.	for model	Length L mm	Height H mm	Width B mm	Depth T mm
YTS-01-GA	12702005	YTS-01	90	42	29	21
YTS-02-GA	12701882	YTS-02	114	55	39	28
YTS-03-GA	12702006	YTS-03	159	74	52	42

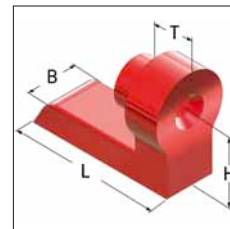

Inline reaction pad  
Direct housing reaction allows use without reaction arm.

Technical data YTS extended reaction tube

Model	EAN-No. 4025092*	for model	Diameter mm	Length L mm
YTS-01-RR	*485210	YTS-01	51	472
YTS-02-RR	*485227	YTS-02	67	603
YTS-03-RR	*485234	YTS-03	89	584
YTS-04-RR	*485241	YTS-04	95	638
YTS-05-RR	*485258	YTS-05	127	419



Technical data YTS end cap

Model	Art.-No.	for model
YTS-01-EK	12701999	YTS-01
YTS-02-EK	12702000	YTS-02
YTS-03-EK	12702001	YTS-03
YTS-04-EK	12702002	YTS-04
YTS-05-EK	12702003	YTS-05
YTS-06-EK	12702004	YTS-06



End cap protector  
Protects spline drive when working without reaction arm.



Direct socket drive  
Impact socket with integrated square drive.



Direct allen hex drive adapter  
For use with allen hex drive screws.

Available in all metric and imperial sizes!  
Specify AF size



## Hydraulic torque wrench model YTF

Torque wrenches series YTF consist of a drive unit (YTF-01 to YTF-05) and an interchangeable link according to nut-size.

### Features

- Cylinder and link body are manufactured from high grade, high strength steel alloy.
- In-Line reaction pad, this ensures torsion free reaction during use.
- Flat design of cylinder and link ensures tool sits flat on flange surface. Allows use in most confined areas.
- Dual 360° swivel allows free 360° individual movement of duplex hoses for secure working conditions, also in confined spaces.
- Non-drip 4:1 safety ratio couplers. Assure safe operation with ease for engaging and disengaging of hoses.

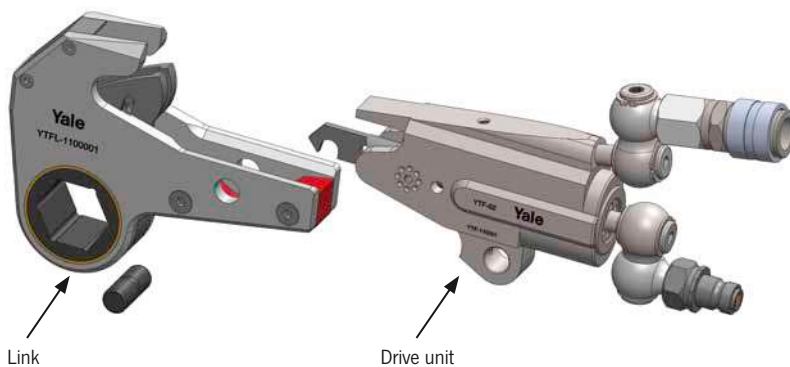

**A choice of common link sizes are listed in the charts shown on pages 14 and 16.**

### Technical data model YTF - Drive unit

Model	EAN-No. 4025092*	Tool hex sizes AF*		Torque min.		Torque max.		Accuracy	Repeat-ability	Weight	
		mm	inch	Nm	Ft.lbs	Nm	Ft.lbs			kg	lbs
YTF-01	*472630	19 up to 60	3/4" up to 2 3/8"	260	192	2614	1928	± 3%	100%	1.7	3.80
YTF-02	*472685	25 up to 80	1" up to 3 1/8"	535	395	5356	3950	± 3%	100%	3.0	6.50
YTF-03	*472708	50 up to 105	1 7/8" up to 4"	1125	830	11702	8630	± 3%	100%	6.0	12.80
YTF-04	*472722	65 up to 115	2 5/8" up to 4 5/8"	2115	1560	22500	16600	± 3%	100%	7.5	16.50
YTF-05	*472753	80 up to 155	3 1/8" up to 6 1/8"	4366	3220	48341	35650	± 3%	100%	12.2	26.90

\*other sizes on request



Link pin

One single pin for cassette link to cylinder engagement without using any additional or special tool.

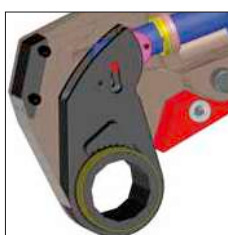

Drive plate

Single piece high strength alloy drive plate for maximum life. Allows small nose radius for the tool.

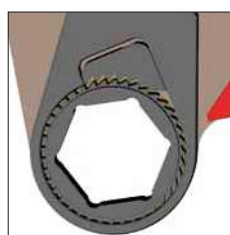

Multi tooth ratchet

Highest strength teeth ensures 28° torque stroke with greatest accuracy.

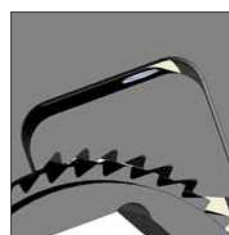

Never lock drive segment

Never lock drive segment does not let the wrench lock and thus eliminates the requirement of a ratchet release mechanism.

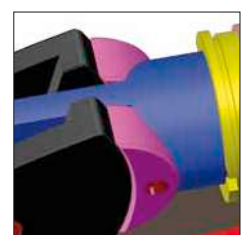

Silders

Reduce friction and prevent wear on the piston

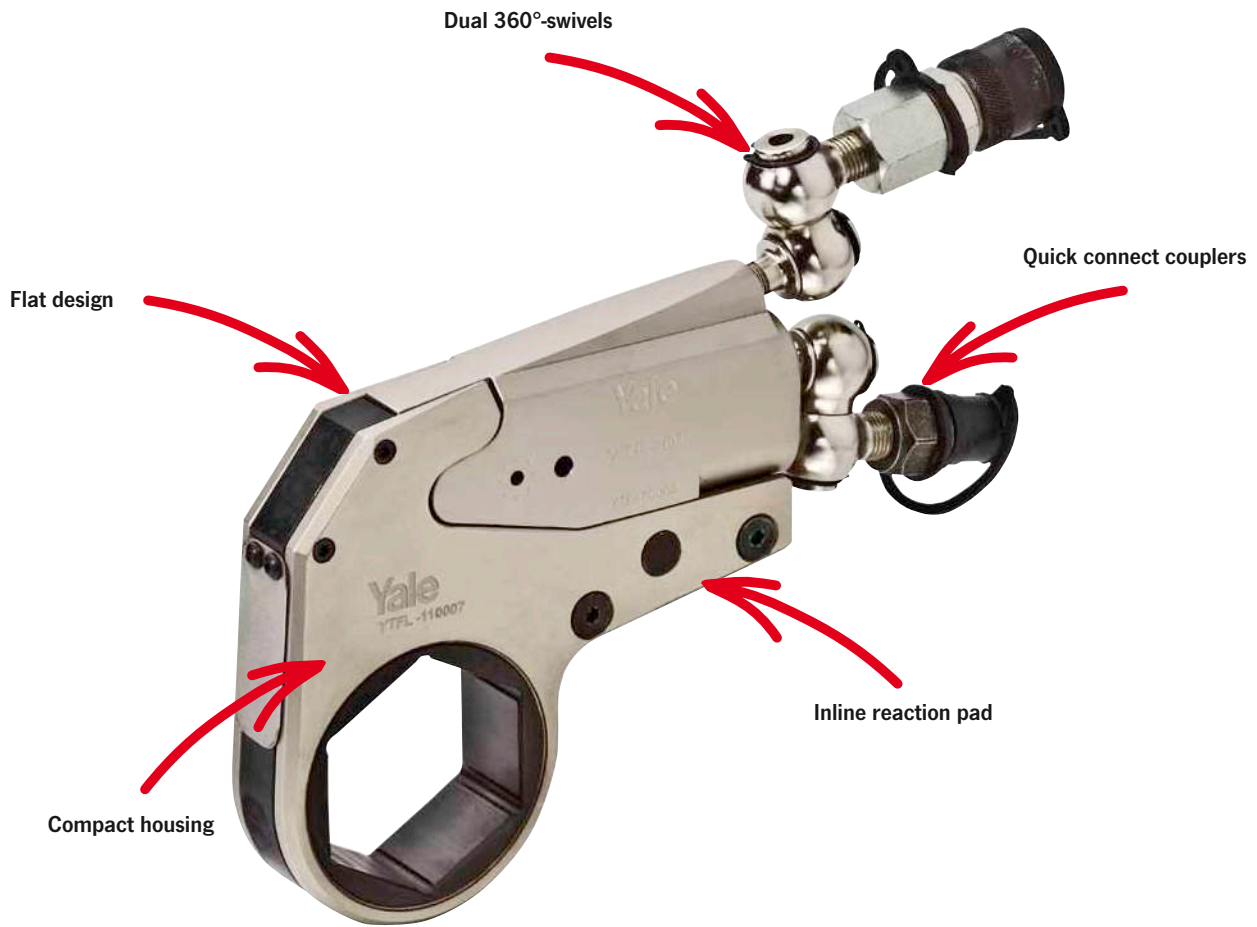

Dimensions model YTF - Drive unit

Model	YTF-01		YTF-02		YTF-03		YTF-04		YTF-05	
	mm	inch	mm	inch	mm	inch	mm	inch	mm	inch
A	147.0	5.78	203.2	8.00	253	9.96	330	13.00	390	15.35
B	103.0	4.05	144.0	5.66	179.5	7.06	193.8	7.63	278	10.94
C	38.0	1.49	50.7	1.99	59.5	2.34	65	2.56	84	3.30
D	9.3	0.36	11.9	0.46	13.9	0.54	16.8	0.66	23.8	0.94



**Alignment pins**  
Ensure equal load distribution between the two side plates.



**Sealings**  
High temperature polyurethane seals ensure years of maintenance free operation.

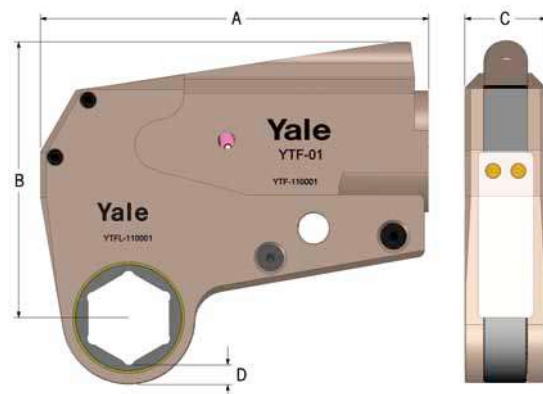



Links

Drive unit

Each size of drive unit (YTF-01 to YTF-05) can be combined with different sizes of interchangeable links, see charts on the right and page 16

By using hex reducer inserts each link size can be used for smaller nut sizes.

How to find the right product is shown on page 16.

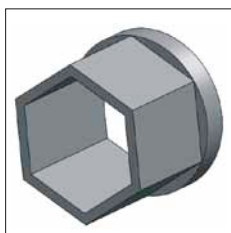

Hex reducer inserts

Easy to change. Each link size can be used for smaller nut sizes, too.

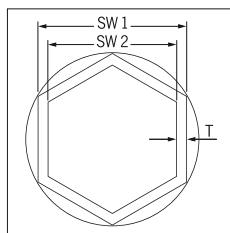

## Technical data links for model YTF-01

Links			
Model	EAN-No. 4025092*	Width across flats AF mm	Weight kg
YTF-01-K19.3/4	*472937	19	1.9
YTF-01-K22.7/8	*472975	22	2.9
YTF-01-K27.1-1/16	*473057	27	3.9
YTF-01-K30.1-3/16	*473101	30	4.9
YTF-01-K32	*473194	32	5.9
YTF-01-K34	*473217	34	6.9
YTF-01-K36	*473262	36	7.9
YTF-01-K41.1-5/8	*473347	41	8.9
YTF-01-K46.1-13/16	*473408	46	9.9
YTF-01-K50	*473460	50	10.9
YTF-01-K55.2-3/16	*473545	55	11.9
YTF-01-K60.2-3/8	*473613	60	12.9

## Technical data links for model YTF-02

Links			
Model	EAN-No. 4025092*	Width across flats AF mm	Weight kg
YTF-02-K27.1-1/16	*473682	27	1.9
YTF-02-K30.1-3/16	*473705	30	2.9
YTF-02-K32	*473729	32	3.9
YTF-02-K34	*473750	34	4.9
YTF-02-K36	*473767	36	5.9
YTF-02-K38.1-1/2	*473781	38	6.9
YTF-02-K41.1-5/8	*473804	41	7.9
YTF-02-K46.1-13/16	*473835	46	8.9
YTF-02-K50	*473866	50	9.9
YTF-02-K55.2-3/16	*473903	55	10.9
YTF-02-K60.2-3/8	*473934	60	11.9
YTF-02-K65.2-9/16	*473965	65	12.9
YTF-02-K70.2-3/4	*474016	70	9.9
YTF-02-K75.2-15/16	*474122	75	10.9
YTF-02-K80	*474221	80	11.9

## Technical data links for model YTF-03

Links			
Model	EAN-No. 4025092*	Width across flats AF mm	Weight kg
YTF-03-K50	*474283	50	1.9
YTF-03-K55.2-3/16	*474399	55	2.9
YTF-03-K60.2-3/8	*474467	60	3.9
YTF-03-K65.2-9/16	*474610	65	4.9
YTF-03-K70.2-3/4	*474702	70	5.9
YTF-03-K75.2-15/16	*474863	75	6.9
YTF-03-K80	*474948	80	7.9
YTF-03-K85	*475051	85	8.9
YTF-03-K90	*475136	90	9.9
YTF-03-K95.3-3/4	*475211	95	10.9
YTF-03-K100.3-15/16	*475273	100	11.9
YTF-03-K105.4-1/8	*475358	105	12.9
YTF-03-K110	*475372	110	9.9
YTF-03-K115	*475426	115	10.9

**Other link sizes and imperial dimensions are available on request.**

Optional hex reducers for model YTF-01

Hex reducer size 1			Hex reducer size 2			Hex reducer size 3		
Model	EAN-No. 4025092*	Width across flats AF1/AF2 mm	Model	EAN-No. 4025092*	Width across flats AF1/AF2 mm	Model	EAN-No. 4025092*	Width across flats AF1/AF2 mm
-	-	-	-	-	-	-	-	-
-	-	-	-	-	-	-	-	-
YTF-01-HR27-24	*479615	27/24	YTF-01-HR27-22	*479639	27/22	YTF-01-HR27-19	*479660	27/19
YTF-01-HR30-27	*479677	30/27	YTF-01-HR30-24	*479691	30/24	YTF-01-HR30-22	*479714	30/22
YTF-01-HR32-27	*479738	32/27	YTF-01-HR32-22	*479769	32/22	YTF-01-HR32-19	*479783	32/19
YTF-01-HR34-30	*479806	34/30	YTF-01-HR34-27	*479820	34/27	YTF-01-HR34-22	*479851	34/22
YTF-01-HR36-34	*479875	36/34	YTF-01-HR36-32	*479899	36/32	YTF-01-HR36-30	*479936	36/30
YTF-01-HR41-38	*480116	41/38	YTF-01-HR41-36	*480147	41/36	YTF-01-HR41-35	*480161	41/35
YTF-01-HR46-41	*480222	46/41	YTF-01-HR46-38	*480284	46/38	YTF-01-HR46-36	*480284	46/36
YTF-01-HR50-46	*480420	50/46	YTF-01-HR50-41	*480444	50/41	YTF-01-HR50-38	*480468	50/38
YTF-01-HR55-50	*480482	55/50	YTF-01-HR55-49	*480505	55/49	YTF-01-HR55-46	*480536	55/46
YTF-01-HR60-55	*480543	60/55	YTF-01-HR60-50	*480567	60/50	YTF-01-HR60-49	*480574	60/49

Optional hex reducers for model YTF-02

Hex reducer size 1			Hex reducer size 2			Hex reducer size 3		
Model	EAN-No. 4025092*	Width across flats AF1/AF2 mm	Model	EAN-No. 4025092*	Width across flats AF1/AF2 mm	Model	EAN-No. 4025092*	Width across flats AF1/AF2 mm
-	-	-	-	-	-	-	-	-
-	-	-	-	-	-	-	-	-
YTF-02-HR32-27	*480581	32/27	-	-	-	-	-	-
YTF-02-HR34-30	*480598	34/30	YTF-02-HR34-27	*480604	34/27	-	-	-
YTF-02-HR36-32	*480611	36/32	YTF-02-HR36-30	*480628	36/30	YTF-02-HR36-27	*480635	36/27
YTF-02-HR38-32	*480642	38/32	YTF-02-HR38-30	*480659	38/30	YTF-02-HR38-27	*480666	38/27
YTF-02-HR41-36	*480673	41/36	YTF-02-HR41-32	*480680	41/32	YTF-02-HR41-30	*480697	41/30
YTF-02-HR46-41	*480703	46/41	YTF-02-HR46-38	*480710	46/38	YTF-02-HR46-36	*480727	46/36
YTF-02-HR50-46	*480765	50/46	YTF-02-HR50-41	*480772	50/41	YTF-02-HR50-38	*480789	50/38
YTF-02-HR55-50	*480819	55/50	YTF-02-HR55-49	*480833	55/49	YTF-02-HR55-46	*480857	55/46
YTF-02-HR60-55	*480871	60/55	YTF-02-HR60-50	*480970	60/50	YTF-02-HR60-49	*481038	60/49
YTF-02-HR65-60	*481106	65/60	YTF-02-HR65-55	*481120	65/55	YTF-02-HR65-50	*481151	65/50
YTF-02-HR70-65	*481243	70/65	YTF-02-HR70-60	*481267	70/60	YTF-02-HR70-55	*481298	70/55
YTF-02-HR75-70	*481335	75/70	YTF-02-HR75-65	*481373	75/65	YTF-02-HR75-60	*481403	75/60
YTF-02-HR80-75	*481427	80/75	YTF-02-HR80-70	*481458	80/70	YTF-02-HR80-65	*481526	80/65

Optional hex reducers for model YTF-03

Hex reducer size 1			Hex reducer size 2			Hex reducer size 3		
Model	EAN-No. 4025092*	Width across flats AF1/AF2 mm	Model	EAN-No. 4025092*	Width across flats AF1/AF2 mm	Model	EAN-No. 4025092*	Width across flats AF1/AF2 mm
-	-	-	-	-	-	-	-	-
-	-	-	-	-	-	-	-	-
YTF-03-HR55-50	*481540	55/50	-	-	-	-	-	-
YTF-03-HR60-55	*481557	60/55	YTF-03-HR60-50	*481700	60/50	-	-	-
YTF-03-HR65-60	*481731	65/60	YTF-03-HR65-55	*481786	65/55	YTF-03-HR65-50	*481809	65/50
YTF-03-HR70-65	*481847	70/65	YTF-03-HR70-60	*481861	70/60	YTF-03-HR70-55	*481885	70/55
YTF-03-HR75-70	*481915	75/70	YTF-03-HR75-65	*481946	75/65	YTF-03-HR75-60	*481960	75/60
YTF-03-HR80-75	*481984	80/75	YTF-03-HR80-70	*482035	80/70	YTF-03-HR80-65	*482073	80/65
YTF-03-HR85-80	*482097	85/80	YTF-03-HR85-75	*482127	85/75	YTF-03-HR85-70	*482158	85/70
YTF-03-HR90-85	*482189	90/85	YTF-03-HR90-80	*482233	90/80	YTF-03-HR90-75	*482257	90/75
YTF-03-HR95-90	*482271	95/90	YTF-03-HR95-85	*482318	95/85	YTF-03-HR95-80	*482325	95/80
YTF-03-HR100-95	*482356	100/95	YTF-03-HR100-90	*482370	100/90	YTF-03-HR100-85	*482387	100/85
YTF-03-HR105-100	*482424	105/100	YTF-03-HR105-95	*482448	105/95	YTF-03-HR105-90	*482479	105/90
YTF-03-HR110-105	*482509	110/105	YTF-03-HR110-100	*482523	110/100	YTF-03-HR110-95	*482547	110/95
YTF-03-HR115-110	*482578	115/110	YTF-03-HR115-105	*482608	115/105	YTF-03-HR115-100	*482622	115/100



## Information for selecting a product:

First select the drive unit suitable for your application by using the table on page 12.

Example: You require a hydraulic torque wrench with a maximum tightening torque of 8000 Nm.

Model YTF-03 therefore is the suitable drive unit (max. tightening torque 11702 Nm).

When selecting the torque wrench, note that for loosening bolted connections in most cases a higher torque is required than for tightening. Depending on the condition of the bolted connection (corrosion etc.), the loosening torque may be up to 2.5 times higher than the tightening torque.

Then select the link suitable for the selected drive unit and the appropriate nut size (A/F) using the tables on pages 14 and 16.

Example: For the selected drive unit YTF-03 and a nut size (A/F) to be processed of 85 mm, link YTF-03-K85 is the correct product to be selected.

It is also possible to use each link for smaller nut sizes (A/F) by means of reducers which are simply inserted in the individual links. You will find a selection of common reducer sizes on pages 15 and 17.

Example: If you want to use the selected link YTF-03-K85 also for a nut size (A/F) of 75 mm, reducer YTF-03-HR85-75 is the correct product to be selected in accordance with the table on page 15.

Note: The reducers listed on pages 15 and 17 only show a standard selection. For the sake of clarity, we have only specified 3 reducer sizes for each link in these tables. Do not hesitate to send us an enquiry, if you need other sizes.

## Technical data links for model YTF-04

Links			
Model	EAN-No. 4025092*	Width across flats AF mm	Weight kg
YTF-04-K70.2-3/4	*475785	70	1.9
YTF-04-K75.2-15/16	*475846	75	2.9
YTF-04-K80	*475921	80	3.9
YTF-04-K85	*476003	85	4.9
YTF-04-K90	*476089	90	5.9
YTF-04-K95.3-3/4	*476164	95	6.9
YTF-04-K100.3-15/16	*476225	100	7.9
YTF-04-K105.4-1/8	*476270	105	8.9
YTF-04-K110	*476454	110	9.9
YTF-04-K115	*476560	115	10.9

## Technical data links for model YTF-05

Links			
Model	EAN-No. 4025092*	Width across flats AF mm	Weight kg
YTF-05-K80	*477000	80	1.9
YTF-05-K85	*477116	85	2.9
YTF-05-K90	*477215	90	3.9
YTF-05-K95.3-3/4	*477307	95	4.9
YTF-05-K98	*477529	98	5.9
YTF-05-K100.3-15/16	*477550	100	6.9
YTF-05-K105.4-1/8	*477628	105	1.9
YTF-05-K110	*477734	110	2.9
YTF-05-K115	*477826	115	3.9
YTF-05-K120	*477925	120	4.9
YTF-05-K125	*478038	125	5.9
YTF-05-K130	*478120	130	6.9
YTF-05-K135	*478229	135	7.9
YTF-05-K140	*478359	140	8.9
YTF-05-K145	*478434	145	9.9
YTF-05-K150	*478557	150	10.9
YTF-05-K155	*478755	155	11.9
YTF-05-K160	*478847	160	12.9
YTF-05-K165.6-1/2	*478922	165	9.9

**Other link sizes and imperial dimensions are available on request.**



Optional hex reducers for model YTF-04

Hex reducer size 1			Hex reducer size 2			Hex reducer size 3		
Model	EAN-No. 4025092*	Width across flats AF1/AF2 mm	Model	EAN-No. 4025092*	Width across flats AF1/AF2 mm	Model	EAN-No. 4025092*	Width across flats AF1/AF2 mm
YTF-04-HR70-65	*482721	70/65	YFT-04-HR70-60	*482752	70/60	YFT-04-HR70-55	*482783	70/55
YTF-04-HR75-70	*482813	75/70	YTF-04-HR75-65	*482837	75/65	YTF-04-HR75-60	*482851	75/60
YTF-04-HR80-75	*482875	80/75	YFT-04-HR80-70	*482899	80/70	YFT-04-HR80-65	*482936	80/65
YTF-04-HR85-80	*482950	85/80	YTF-04-HR85-75	*482974	85/75	YFT-04-HR85-70	*482998	85/70
YTF-04-HR90-85	*483018	90/85	YTF-04-HR90-80	*483049	90/80	YTF-04-HR90-75	*483100	90/75
YTF-04-HR95-90	*483124	95/90	YTF-04-HR95-85	*483148	95/85	YTF-04-HR95-80	*483162	95/80
YTF-04-HR100-95	*483193	100/95	YTF-04-HR100-90	*483223	100/90	YTF-04-HR100-85	*483247	100/85
YTF-04-HR105-100	*483261	105/100	YTF-04-HR105-95	*483285	105/95	YTF-04-HR105-90	*483322	105/90
YTF-04-HR110-105	*483353	110/105	YTF-04-HR110-100	*483377	110/100	YTF-04-HR110-95	*483391	110/95
YTF-04-HR115-110	*483414	115/110	YTF-04-HR115-105	*483438	115/105	YTF-04-HR115-100	*483452	115/100

Optional hex reducers for model YTF-05

Hex reducer size 1			Hex reducer size 2			Hex reducer size 3		
Model	EAN-No. 4025092*	Width across flats AF1/AF2 mm	Model	EAN-No. 4025092*	Width across flats AF1/AF2 mm	Model	EAN-No. 4025092*	Width across flats AF1/AF2 mm
-	-	-	-	-	-	-	-	-
YTF-05-HR85-80	*483490	85/80	-	-	-	-	-	-
YTF-05-HR90-85	*483568	90/85	YFT-05-HR90-80	*483629	90/80	-	-	-
YTF-05-HR95-90	*483643	95/90	YTF-05-HR95-85	*483810	95/85	YFT-05-HR95-80	*483841	95/80
YTF-05-HR98-90	*483865	98/90	YTF-05-HR98-85	*483889	98/85	YTF-05-HR98-80	*483902	98/80
YTF-05-HR100-95	*483926	100/95	YTF-05-HR100-90	*483940	100/90	YTF-05-HR100-85	*483964	100/85
YTF-05-HR105-100	*484008	105/100	YTF-05-HR105-95	*484022	105/95	YTF-05-HR105-90	*484046	105/90
YTF-05-HR110-105	*484114	110/105	YTF-05-HR110-100	*484138	110/100	YTF-05-HR110-95	*484152	110/95
YTF-05-HR115-110	*484176	115/110	YTF-05-HR115-105	*484206	115/105	YTF-05-HR115-100	*484275	115/100
YTF-05-HR120-115	*484299	120/115	YTF-05-HR120-110	*484312	120/110	YFT-05-HR120-105	*484336	120/105
YTF-05-HR125-120	*484350	125/120	YTF-05-HR125-115	*484374	125/115	YTF-05-HR125-110	*484398	125/110
YTF-05-HR130-125	*484411	130/125	YTF-05-HR130-120	*484435	130/120	YTF-05-HR130-115	*484466	130/115
YTF-05-HR135-130	*484497	135/130	YTF-05-HR135-125	*484503	135/125	YTF-05-HR135-120	*484534	135/120
YTF-05-HR140-135	*484596	140/135	YTF-05-HR140-130	*484619	140/130	YTF-05-HR140-125	*484633	140/125
YTF-05-HR145-140	*484664	145/140	YTF-05-HR145-135	*484688	145/135	YTF-05-HR145-130	*484701	145/130
YTF-05-HR150-145	*484725	150/145	YTF-05-HR150-140	*484732	150/140	YTF-05-HR150-135	*484763	150/135
YTF-05-HR155-150	*484787	155/150	YTF-05-HR155-145	*484824	155/145	YTF-05-HR155-140	*484855	155/140
YTF-05-HR160-155	*513579	160/155	YTF-05-HR160-150	*513593	160/150	YTF-05-HR160-145	*513623	160/145
YTF-05-HR165-160	*513678	165/160	YTF-05-HR165-155	*513692	165/155	YTF-05-HR165-150	*513715	165/150

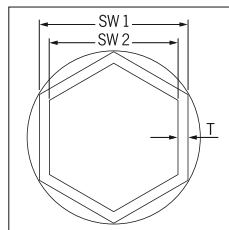
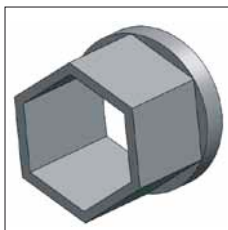

**!** Other hex reducers are available on request.

Hex reducer inserts

Easy to change. Each link size can be used for smaller nut sizes, too.

**Accessories for model YTF**

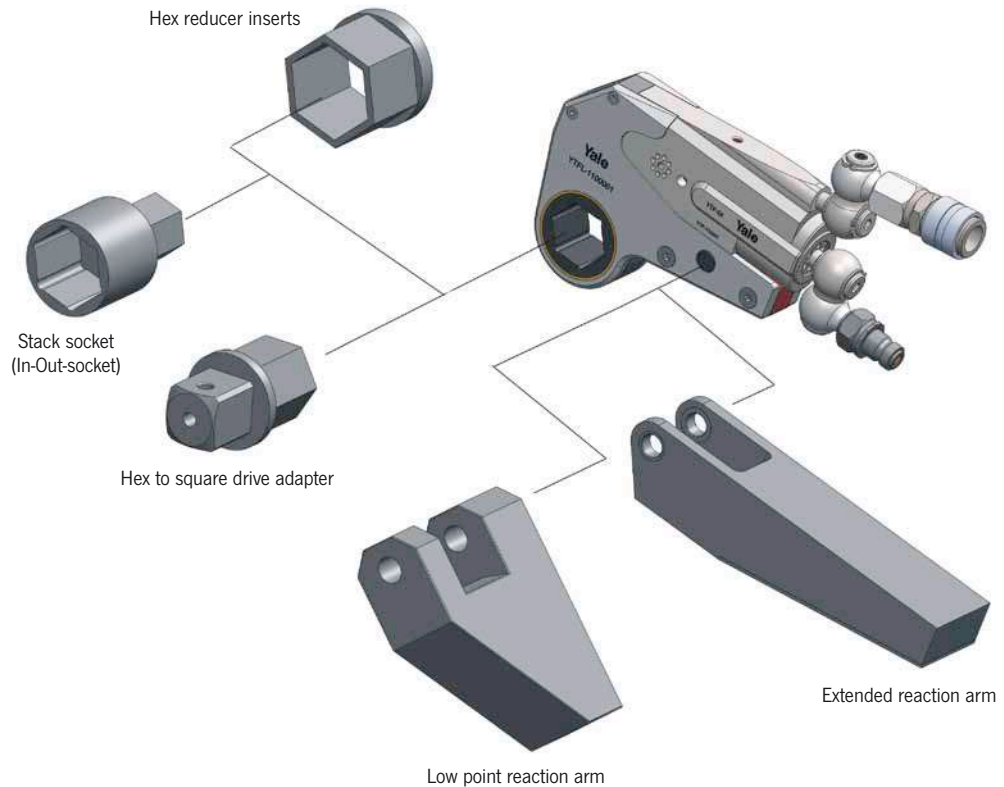

**!** Other sizes are available on request

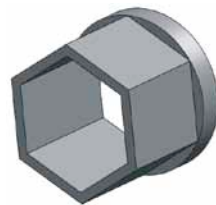

**Hex reducer inserts**

Easy to change. Each link size can be used for smaller nut sizes, too. A standard choice of common sizes are listed in the charts on pages 15 and 17.

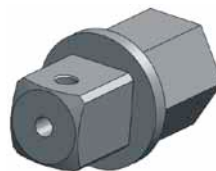

**Hex to square drive adapters**

Adapters for use of YTF-wrenches with standard impact-sockets. One side of the adapter is according to link-size, the other side has a square drive.

The following adapter-sizes are available as standard, other sizes are available on request:

- For all link-sizes up to AF 55 mm, adapters with square drive 3/4" or 1".
- For all link-sizes from AF 60 mm, adapters with square drive 1" or 1 1/2".
- For all link sizes from AF 90 mm, adapters with square drive 1 1/2" or 2 1/2".

**Stack socket (In-Out-socket)**

Special socket for direct use without square-drive adapter.  
Stack socket will be inserted directly into the link.

Available for all nut sizes on request.

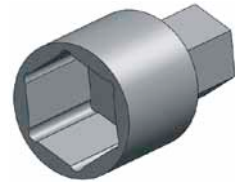

**Technical data low point reaction arm**

Model	EAN-No. 4025092*	Length L		Width B		Height H1		Height H2	
		mm	inch	mm	inch	mm	inch	mm	inch
YTF-01-AS	*485265	111	4.35	26	1.03	38	1.49	83	3.26
YTF-02-AS	*485272	144	5.65	31	1.23	51	2.02	107	4.23
YTF-03-AS	*485289	182	7.15	45	1.78	64	2.53	136	5.35
YTF-04-AS	*485296	230	9.05	64	2.51	77	3.04	162	6.36
YTF-05-AS	*485302	285	11.20	83	3.26	100	3.95	211	8.30

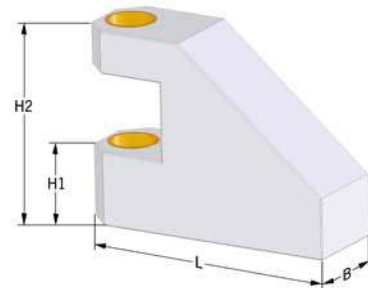

**Technical data extended reaction arm**

Model	EAN-No. 4025092*	Length L		Width B		Height H	
		mm	inch	mm	inch	mm	inch
YTF-01-AL	*485319	503	19.80	39	1.54	48	1.90
YTF-02-AL	*485326	515	20.29	52	2.05	61	2.40
YTF-03-AL	*485333	530	20.85	64	2.52	77	3.03
YTF-04-AL	*485340	546	21.50	77	3.04	93	3.65
YTF-05-AL	*485357	566	22.28	99	3.90	115	4.52

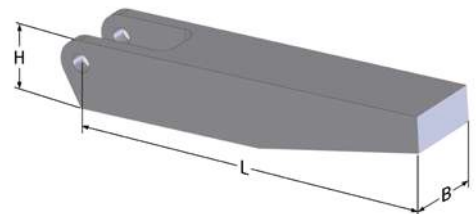

**Technical data backup wrench**

Model	Interchangeable insert	EAN-No. 4025092*	Width across flats AF mm
Handle YBW-01  EAN-No. 4025092485364	BC-19M	*485371	19
	BC-22M	*485388	22
	BC-24M	*485395	24
	BC-27M	*485401	27
	BC-30M	*485418	30
	BC-32M	*485425	32
	BC-36M	*485432	36
	BC-41M	*485449	41
	BC-46M	*485456	46
	BC-50M	*485463	50
	BC-55M	*485470	55
	BC-60M	*485487	60
	BC-65M	*485494	65
	BC-70M	*485500	70
	BC-75M	*485517	75
	BC-80M	*485524	80



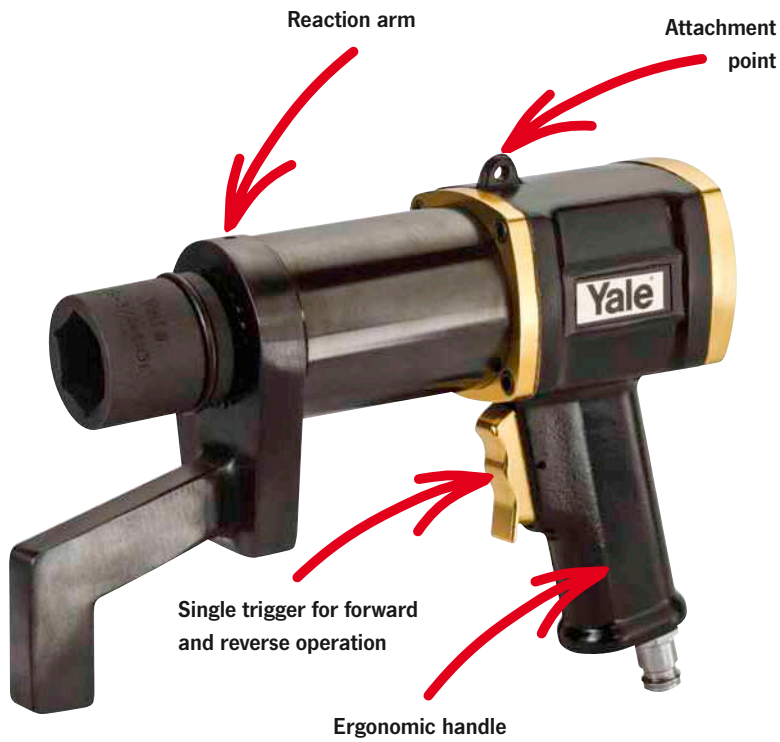

## Pneumatic torque wrenches model YPTW

### Features

- Light weight rugged construction for better torque to weight ratio.
- Heavy duty gear assembly train with precision gear tooth profile for smooth, reliable and accurate operation.
- Single trigger for both forward and reverse operation.
- Integral hook for suspending (spring balancer etc.).
- Low noise/vibration for better working conditions.
- Accuracy more than  $\pm 5\%$  with repeatability within 2%.
- Reaction arm blanks available for different customized requirements.
- Wheel extensions available for ease & accuracy of operation.
- Accessories like universal socket, universal joint & thin wall sockets available.

### Option

- FRL-unit with spiral hose.



Technical data model YPTW

Model	EAN-No. 4025092*	Square drive inch	Torque min.		Torque max.		Accuracy	A		B		C		ØD		Weight	
			Nm	Ft.lbs	Nm	Ft.lbs		mm	inch	mm	inch	mm	inch	mm	inch	kg	lbs
YPTW-400	*513807	1/2"	50	35	400	300	±5%	220	8.66	86	3.39	195	7.68	76	3.00	4.5	9.9
YPTW-600	*513876	3/4"	120	90	600	450	±5%	220	8.66	86	3.39	252	9.92	76	3.00	4.9	10.8
YPTW-1000	*513920	3/4"	200	150	1000	725	±5%	220	8.66	86	3.39	255	10.04	76	3.00	5.7	12.6
YPTW-2000	*513951	1"	450	330	2000	1475	±5%	220	8.66	86	3.39	270	10.63	81	3.18	9.0	19.8
YPTW-4000	*513999	1 1/2"	1300	950	4000	3000	±5%	240	9.45	95	3.74	360	14.17	90	3.54	10.5	23.1

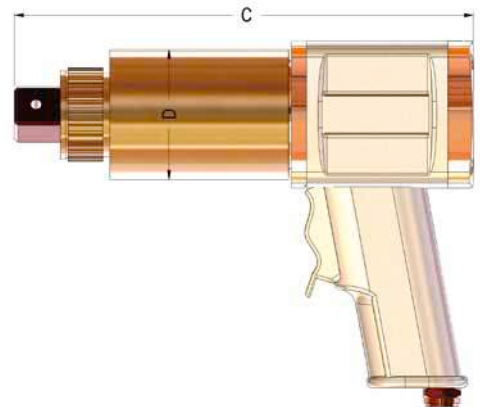
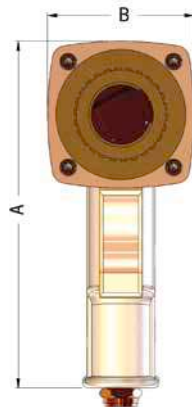

Accessories for model YPTW

Wheel extensions for deep reach, where tool clearance is a problem

Technical data wheel extensions model YTWP-E

Model	EAN-No. 4025092*	Square drive inch	L1		L2		L3		ØD1		ØD2		H	
			mm	inch	mm	inch	mm	inch	mm	inch	mm	inch	mm	inch
YTWP-E210	*514019	3/4"	210	8.27	150	5.91	185	7.28	70	2.76	45	1.77	100	3.94
YTWP-E260	*514033	3/4"	260	10.24	200	7.87	235	9.25	70	2.76	45	1.77	100	3.94
YTWP-E310	*514057	3/4"	310	12.20	250	9.84	285	11.22	70	2.76	45	1.77	100	3.94
YTWP-E265	*514071	1"	265	10.43	200	7.87	235	9.25	70	2.76	52	2.05	100	3.94
YTWP-E315	*514095	1"	315	12.40	250	9.84	285	11.22	70	2.76	52	2.05	100	3.94
YTWP-E265H	*514118	1"	265	10.43	200	7.87	235	9.25	90	3.54	60	2.36	130	5.12

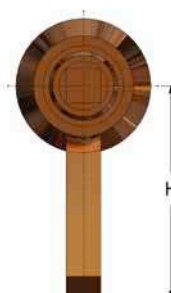
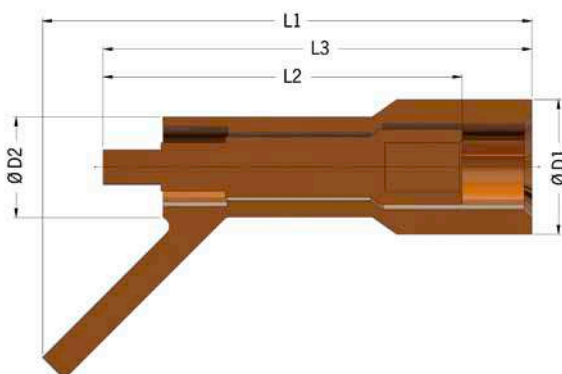

## Hydraulic nut splitters model YNS-AH and model YNS

Cut only the nut, not the bolt. With these nuts splitters nuts with max. 136 mm AF can be cut. No sparks. No flames. No risk to volatile surroundings. No hammers or impact needed. No flying fragments.

### Features

- Cutting head fabricated from high strength, hardened steel alloy for longer lifetime. Chisels can be resharpened.
- Nut splitters up to 98 mm AF are "angle-headed", for use in space restricted areas.

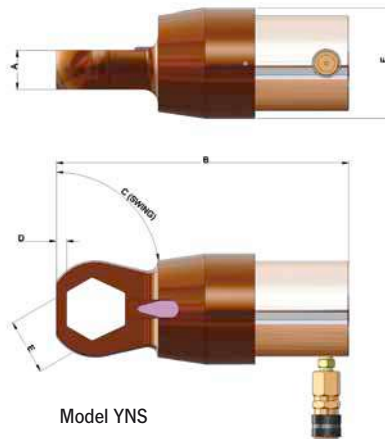

Model YNS

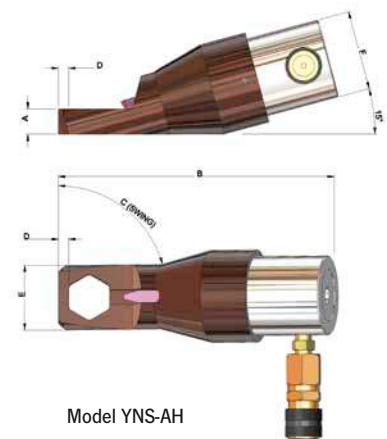

Model YNS-AH

### Technical data model YNS-AH and model YNS metric

Model	EAN-No. 4025092*	Stud-Ø mm	Width across flats AF mm	A mm	B mm	C	D mm	E mm	F mm	Weight kg
YNS-AH1324	*514323	11-16	13-24	18	190	30°	6	65	72	4
YNS-AH1636	*514347	11-22	16-36	38	280	60°	10	70	105	13
YNS-AH3651	*514392	22-32	36-51	38	290	45°	13	95	108	14
YNS-AH4660	*514415	32-38	46-60	57	410	30°	15	108	164	38
YNS-AH5770	*514439	35-45	57-70	57	420	30°	18	130	164	39
YNS-AH7089	*514453	45-57	70-89	78	500	30°	20	160	214	79
YNS-AH7998	*514477	50-64	79-98	80	510	30°	23	175	214	92
YNS-95108	*514507	64-70	95-108	95	579	60°	29	118	251	106
YNS-114127	*514538	76-83	114-127	105	590	60°	29	137	251	111
YNS-124136	*514576	83-89	124-136	105	589	60°	29	149	251	109

### Technical data model YNS-AH and model YNS imperial

Model	EAN-No. 4025092*	Stud-Ø inch	Width across flats AF inch	A inch	B inch	C	D inch	E inch	F inch	Weight lbs
YNS-AH1324	*514323	7/16-5/8	1/2-1	0.69	7.48	30°	0.24	2.56	2.83	9.7
YNS-AH1636	*514347	5/8-7/8	5/8-1 7/16	1.49	11.02	60°	0.39	2.76	4.13	27.9
YNS-AH3651	*514392	7/8-1 1/4	1 7/16-1	1.49	11.42	45°	0.51	3.74	4.25	30.1
YNS-AH4660	*514415	1 1/4-1 1/2	1 13/16-2 3/8	2.24	16.14	30°	0.59	4.25	6.46	83.8
YNS-AH5770	*514439	1 3/8-1 3/4	2 1/4-2 3/4	2.24	16.54	30°	0.71	5.12	6.46	86.7
YNS-AH7089	*514453	1 3/4-2 1/4	2 3/4-3 1/2	3.07	19.69	30°	0.79	6.30	8.43	173.1
YNS-AH7998	*514477	2-2 1/2	3 1/8-3 7/8	3.15	20.08	30°	0.91	6.89	8.43	202.8
YNS-95108	*514507	2 1/2-2 3/4	3 3/4-4 1/4	3.74	22.78	60°	1.14	4.65	9.88	233.2
YNS-114127	*514538	3-3 1/4	4 1/2-5	4.13	23.23	60°	1.14	5.39	9.88	243.1
YNS-124136	*514576	3 1/4-3 1/2	4 7/8-5 3/8	4.13	23.19	60°	1.14	5.87	9.88	238.7

According to the above charts hydraulic cylinders and other common parts are interchangeable, so it will be possible to use these parts for different sizes of nut-splitters. This will reduce costs.

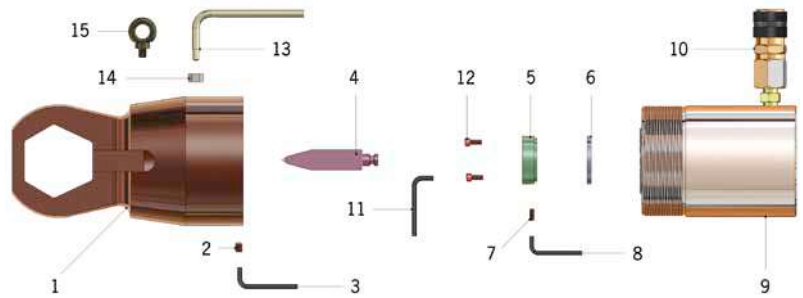

## Components model YNS-AH

Comp.	Model	YNS-AH1324	YNS-AH1636	YNS-AH3651	YNS-AH4660	YNS-AH5770	YNS-AH7089	YNS-AH7998	
	EAN-No. 4025092*	*514323	*514347	*514392	*514415	*514439	*514453	*514477	
1	Cutting head	11000327	11000328	11000329	11000330	11000331	11000332	11000333	
2	Set screw	1			2		3		
3	Allen wrench	11000337			11000338		11000339		
4	Chisel	11000341	11000342		11000343		11000344	11000345	
5	Chisel holder	11000348	11000349	11000350	11000351	11000352	11000353	11000354	
6	Spacer set	11000357	11000358	11000359	11000360	11000361	11000362	11000363	
7	Set screw for chisel holder	1					2		
8	Allen wrench for chisel holder	11000367					11000368		
9	Hydraulic cylinder	11000370	11000371		11000372		11000373		
10	Quick disconnect coupler	1							
11	Allen wrench for cap screws	-	-	-	-	-	-	-	
12	Socket head cap screw	-	-	-	-	-	-	-	
13	Handle for housing	-	-	-	11000377		11000378		
14	Hex nut for handle	-	-	-	1		2		
15	Lifting eye	-	-	-	-	-	11000380		
16	Tool box	11000382			11000383		11000384		

## Components model YNS

Comp.	Model	YNS-95108	YNS-114127	YNS-124136
	EAN-No. 4025092*	*514507	*514538	*514576
1	Cutting head	11000334	11000335	11000336
2	Set screw	4		
3	Allen wrench	11000340		
4	Chisel	11000346	11000347	
5	Chisel holder	11000355	11000356	
6	Spacer set	11000364	11000365	11000366
7	Set screw for chisel holder	3		
8	Allen wrench for chisel holder	11000369		
9	Hydraulic cylinder	11000374		
10	Quick disconnect coupler	1		
11	Allen wrench for cap screws	11000375		
12	Socket head cap screw	11000376		
13	Handle for housing	11000379		
14	Hex nut for handle	3		
15	Lifting eye	11000381		
16	Tool box	11000385		

**Upgrade/Downgrade kits available on request**



Hand pumps model HPS



Foot pump model FPS



Mini hydraulic pumps model PAY

Hydraulic pumps for use with nut-splitters

A selection chart for suitable combination of nut splitters and hydraulic pumps can be found on page 39

## Flange spreaders model FS

Spreading force max. 4.5 t

### Features

- Lightweight
- Jaws open parallel
- Easy one person operation
- Opens to 76 mm (3 inch)
- Model FS-10H with hydraulic cylinder, model FS-10M with ratchet drive for manual operation
- Max. working pressure 700 bar

### Technical data model FS

Model	EAN-No. 4025092*	Spreading force		Stroke		Weight	
		t	lbs	mm	inch	kg	lbs
FS-10H	*485531	4.5	10000	76	3.00	7.7	17.0
FS-10M	*485548	4.5	10000	76	3.00	7.0	15.4



Model FS-10H, hydraulic



Model FS-10M, manual

## Flange spreaders model FS

Spreading force max. 5 - 10 t

### Features

- Opening stroke max. 29 mm (1.14 inch) with standard wedge
- Min. access gap of only 3 mm is needed.

### Option

- Opening stroke max. 56 mm (2.20 inch) with special wedge



Selection charts for suitable combinations of flange spreaders and hydraulic pumps can be found on page 39

### Technical data model FS

Model	EAN-No. 4025092*	Spreading force		Stroke		Flange thickness max.		Flange dimension		Stud-Ø		Wedge		Special wedge	
		t	lbs	mm	inch	mm	inch	mm	inch	mm	inch	mm	inch	mm	inch
FS-5T	*485555	5	11000	39	1.54	2x58	2x2.28	1150	45	19-29	0.74-1.14	3-29	0.12-1.14	30-56	1.18-2.20
FS-10T	*485562	10	22000	55	2.17	2x93	2x3.66	1900	75	32-41	1.26-1.61	3-29	0.12-1.14	30-56	1.18-2.20

### Dimensions model FS

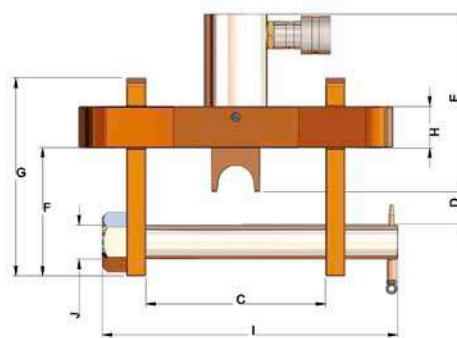
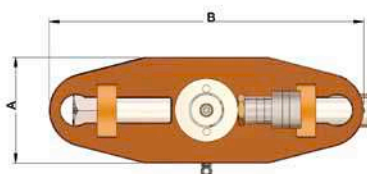

Model	FS-5T		FS-10T	
	mm	inch	mm	inch
A	77	3.03	110	4.33
B	210	8.26	290	11.41
C min.	61	2.40	61	2.40
C max.	157	6.18	226	8.90
D	10	0.39	30	1.18
E	192	7.56	165	6.49
F	69	2.72	89	3.50
G	131	5.16	180	7.09
H	25	0.98	38	1.49
I	205	8.07	274	10.79
J	18	0.71	31	1.22



## Hydraulic lifting wedge model HK-16T

The hydraulic lifting wedge has been developed as an easy to use/cost effective way to find solutions for lifting heavy objects where minimal clearance is available. It will lift objects vertically where an access gap of 3/8" (9.5 mm) or more is available.

The HK-16T will lift an object fast, secure and safe with a lifting force of 16 tons per tool. Multiple units can be used if higher lifting forces are needed.



**Selection charts for suitable combinations of hydraulic lifting wedge and hydraulic pumps can be found on page 39**

### Mini kit

(EAN-No. 4025092485579)

- 1x Lifting wedge HK-16T
- 1x Safety block
- 1x Stepped block
- 1x Instruction manual
- 1x Carrying case



### Standard kit

(Art.-No. 12701802)

- 1x Lifting wedge HK-16T
- 1x 700 bar hydraulic hand pump two-stage
- 1x 700 bar hydraulic hose
- 1x Safety block
- 1x Stepped block
- 1x Instruction manual
- 1x Carrying case

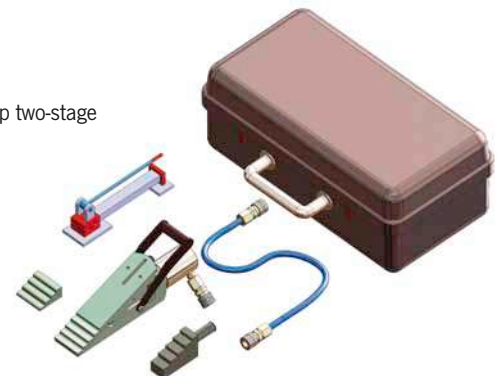

### Dimensions model HK-16T

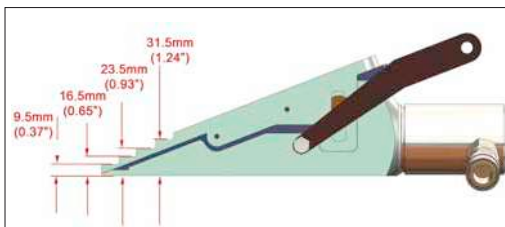

Wedge, closed

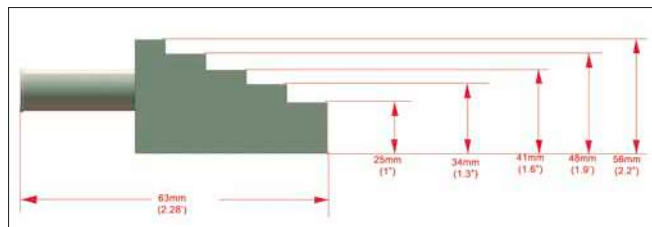

Safety block

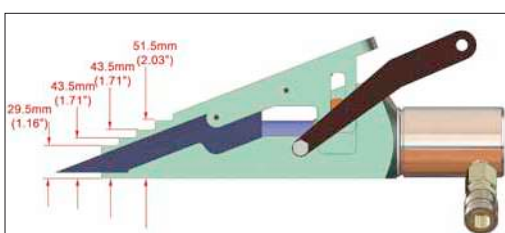

Wedge, opened

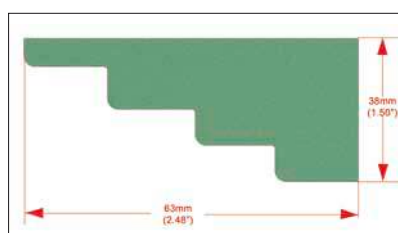

Stepped block



## Hydraulic spreading wedge YSW-14T

The spreading wedge YSW-14T has been developed as the simple cost-effective solution for flange spreading. An access gap of min. 6.5mm is needed. With a max. working pressure of 700 bar the max. spreading force is 14t. The spreading wedge can be operated by using a hydraulic hand pump or foot pump.

### Mini kit

(EAN-No. 4025092438025)

- 1 x Lifting wedge YSW-14T
- 1 x Safety block
- 1 x Instruction manual
- 1 x Carrying case

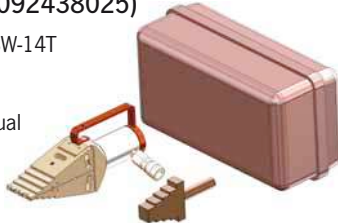

### Stepped block

(EAN-No. 4025092336383)

- 2 x Stepped block
- 2 x Screws CSK M6 x 12 mm
- 1 x Allen key

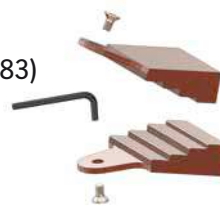

### Standard kit

(EAN-No. 4025092438148)

- 1 x Lifting wedge YSW-14T
- 1 x 700 bar hydraulic hand pump two-stage
- 1 x 700 bar hydraulic hose
- 1 x Safety block
- 1 x Instruction manual
- 1 x Carrying case

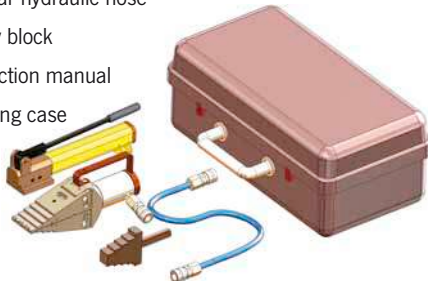

### Maxi kit

(Art.-No. 12701814)

- 2 x Lifting wedge YSW-14T
- 1 x 700 bar hydraulic pump two-stage
- 2 x 700 bar hydraulic hose
- 2 x Safety block
- 1 x Instruction manual
- 1 x Twin manifold block
- 1 x Carrying case

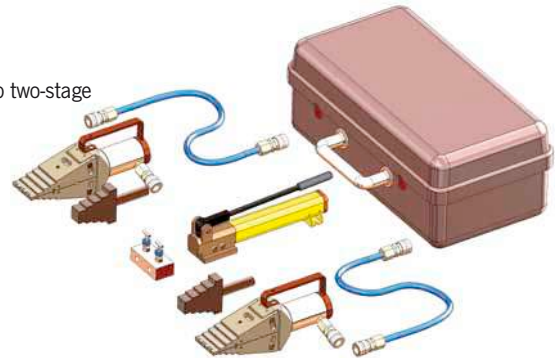

## Dimensions model YSW-14T

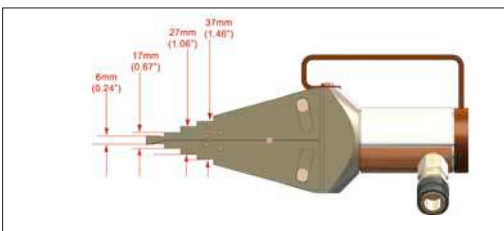

Wedge, closed

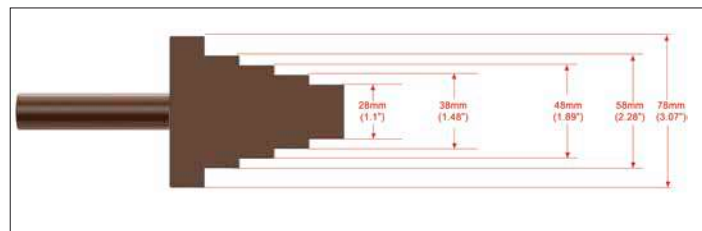

Safety block, side view

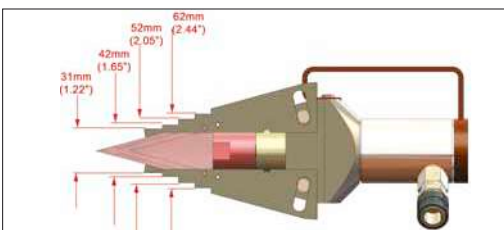

Wedge, opened



Stepped block, top view

**Selection charts for suitable combination of spreading wedge and hydraulic pumps can be found on page 39**

## Torque multiplier model YTM

The given load at the input gets multiplied as per the multiplication factor & transmitted at the output, there by with a minimum efforts you achieve greater load.

### Features

- Accuracy more than  $\pm 4\%$
- Precision tightening and loosening of all heavy duty fasteners.
- Higher capacity multipliers are equipped with strong ratchets (Anti-wind up mechanism) allowing jobs to be performed easily, efficiently, and safely.
- Precision manufacturing ensures long life and premier quality
- A groove on output square breaks if over loaded in excess of 20% of its capacity
- Highest possible load factor is guaranteed due to design and use of forged components.
- Equipped with standard interchangeable reaction plate



For max. torque values up to 47500 Nm

### Technical data model YTM without ratchet mechanism

Model	EAN-No. 4025092*	Torque max.		Ratio	Square drive		ØA		B		C min.		C max.		Weight	
		Nm	Ft.lbs		input inch	output inch	mm	inch	mm	inch	mm	inch	mm	inch	kg	lbs
YTM-2/25	*486262	1700	1250	1:25	1/2"	1"	115	4.53	151	5.94	75	2.95	164	6.46	7	15.40
YTM-5	*486439	2700	2000	1:5	3/4"	1"	136	5.35	135	5.31	89	3.50	260	10.24	8	18.48
YTM-5/25	*486453	2700	2000	1:25	1/2"	1"	136	5.35	163	6.42	89	3.50	260	10.24	12	25.30
YTM-6	*486477	3400	2500	1:5	3/4"	1 1/2"	136	5.35	149	5.87	105	4.13	260	10.24	9	20.24
YTM-6/25	*486491	3400	2500	1:25	1/2"	1 1/2"	136	5.35	176	6.93	105	4.13	260	10.24	12	26.40
YTM-7	*486514	6000	4500	1:5	3/4"	1 1/2"	168	6.61	174	6.85	115	4.13	310	12.20	18	39.60

### Technical data model YTM with ratchet mechanism

Model	EAN-No. 4025092*	Torque max.		Ratio	Square drive		ØA		B		C min.		C max.		Weight	
		Nm	Ft.lbs		input inch	output inch	mm	inch	mm	inch	mm	inch	mm	inch	kg	lbs
YTM-7/25	*486545	6000	4500	1:25	1/2"	1 1/2"	168	6.61	226	8.89	115	4.13	310	12.20	22	48.40
YTM-9/25	*486552	9500	7000	1:25	3/4"	1 1/2"	195	7.68	256	10.01	150	5.91	350	13.78	33	72.60
YTM-9/125	*486576	9500	7000	1:125	1/2"	1 1/2"	195	7.68	301	11.85	150	5.91	350	13.78	36	78.10
YTM-11/25	*486606	17000	12500	1:25	3/4"	2 1/2"	220	8.66	360	14.17	164	6.46	480	18.89	52	114.40
YTM-11/125	*486620	17000	12500	1:125	1/2"	2 1/2"	220	8.66	404	15.90	164	6.46	480	18.89	57	125.40
YTM-13/125	*486651	47500	34900	1:125	3/4"	2 1/2"	315	12.40	550	21.65	164	6.46	480	18.89	80	176.00

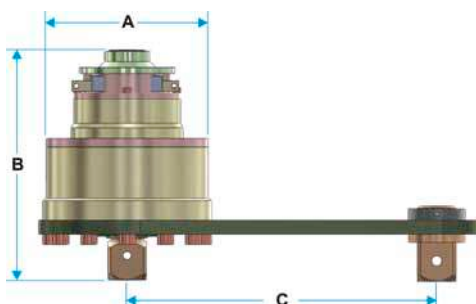

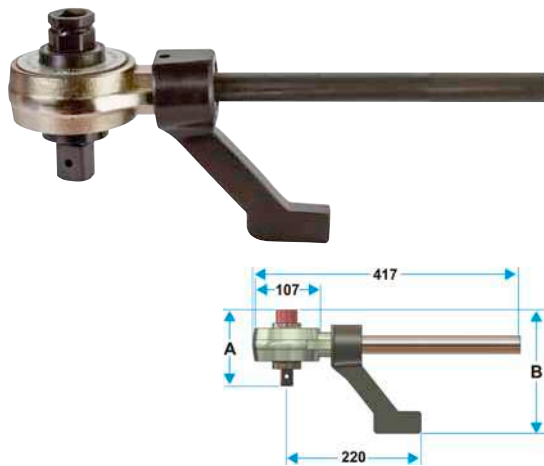

## Manual torque multiplier model YSTN

- Compact, heavy duty torque multiplier with a torque multiplication of 5:1.
- Accuracy more than  $\pm 4\%$  with high repeatability
- Provided with detachable reaction handle.
- Optional offset reaction arm also available on demand.
- Supplied in sturdy molded plastic carrying case for better storage and handling

### Technical data model YSTN

Model	EAN-No. 4025092*	Torque max.		Ratio	Square drive		A		B		Weight		Torque wrench
		Nm	Ft.lbs		input inch	output inch	mm	inch	mm	inch	kg	lbs	
YSTN-17	*486125	1700	1.250	1:5	1/2"	3/4"	107	4.21	115	4.53	3.8	8.38	YTR-3000
YSTN-28	*486149	2800	2.050	1:5	3/4"	1"	107	4.21	126	4.96	3.9	8.60	YTR-5000

In the right column you find the recommended torque wrenches, see also pages 30-31.

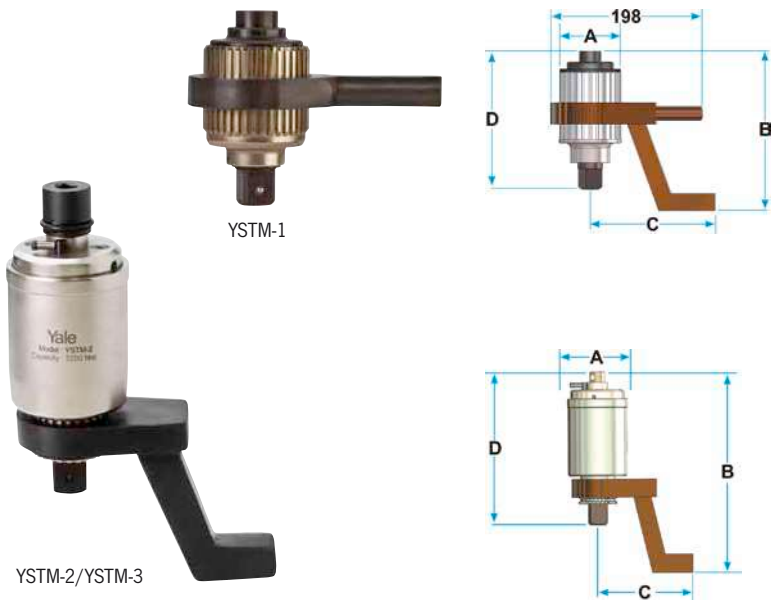

## Manual torque multiplier model YSTM

### Features

- Compact design for the use in confined areas. Higher reduction ratio for low input.
- 3 models with a max. capacity of 4200 Nm.
- Accuracy more than  $\pm 4\%$  with very high repeatability.
- In built anti-windup mechanism reduces operators effort. Can be used with non-ratchet type torque wrench.
- Different type of reaction arm available as per user requirement.
- Safety shear pin at the input provisioned to prevent overloading.
- Supplied in sturdy molded plastic carrying case for better storage and handling.

### Technical data model YSTM

Model	EAN-No. 4025092*	Torque max.		Ratio	Square drive		A		B		C		D		Weight		Torque wrench
		Nm	Ft.lbs		input inch	output inch	mm	inch	mm	inch	mm	inch	mm	inch	kg	lbs	
YSTM-1	*486156	2500	1845	1:8	1/2"	1"	81	3.19	133-175	5.27-6.89	165	6.50	149	5.87	4.3	9.48	YTR-3000
YSTM-2	*486194	3200	2362	1:10	1/2"	1"	88	3.46	272	10.71	141	5.55	207	8.15	6.3	13.89	YTR-3000
YSTM-3	*486224	4200	3100	1:10	3/4"	1 1/2"	88	3.46	272	10.71	151	5.94	217	8.54	6.8	15.00	YTR-5000

In the right column you find the recommended torque wrenches, see also pages 30-31

## Torque wrench model YTW

### Features

- Light weight high strength alloy body reduces its weight to half of the equivalent conventional steel torque wrenches.
- Compact design with multiple extensions, ensures use in confined spaces. Light weight and compact packing allows easy handling and transportation.
- Extension bars can be adjusted to get different extension length as per the operator's requirement.
- Single scale graduation for clear reading, standard scale graduation is in Nm but can be supplied in other scales as required on request.
- 140 Nm to 3000 Nm covered in just four models.
- Accuracy more than  $\pm 3\%$  with very high repeatability.
- Including calibration certificate



### Option

- Suitable ratchet adapters available to convert to ratchet type torque wrench.

### Technical data model YTW

Model	EAN-No. 4025092*	Torque min - max.		Square drive inch	Length		Extension		Weight	
		Nm	Ft.lbs		mm	inch	mm	inch	kg	lbs
YTW-75	*485876	140 - 760	103 - 560	3/4"	810	31.9	-	-	3.5	7.72
YTW-100	*485890	520 - 1000	384 - 738	3/4"	810	31.9	+520	+20.47	5.5	12.13
YTW-200	*485920	750 - 2000	554 - 1476	1"	935	36.8	+675/1075	+26.6/42.3	11.5	25.36
YTW-300	*485944	1500 - 3000	1107 - 2214	1 1/2"	935	36.8	+675/1075	+26.6/42.3	14.0	30.9



**Torque wrench**  
- without ratchet mechanism  
model YT  
- with ratchet mechanism  
model YTR

**Features**

- Push-through square drive. Enables wrench to be turned over and used in opposite direction for tightening/loosening of bolts.
- Cast parts for higher precision.
- Secure and rapid torque setting adjustment. Impossible to alter by accident- ensures accurate setting at all times.
- Ergonomic design
- Large, clear scale markings in Nm, kg/m, lbf/in and Ft.lbs. Accurate setting easily obtained
- Extremely strong construction. Resists all but the most severe accidental damage.
- Compact design, head is not wider than a typical socket for improved access to confined spaces.
- Hard-wearing, heavy-duty mechanism. Retains original accuracy  $\pm 3\%$  for up to 10000 operations without recalibration
- Progressive torque build-up to the selected setting easily detected by sight, sound and feel.
- Easy adjustment of the torque which cannot readjust unnoticed during operation.



**Torque wrench**

- without ratchet mechanism  
model YT and model YQW

- with ratchet mechanism  
model YTR and model YQW-R

**Technical data model YT and model YTR 3/8"**

Model	Art.-No.	Ratchet	Torque		Square drive inch	Length		Weight	
			Nm	Ft.lbs		mm	inch	kg	lbs
YT-100	12701910	no	2.5 - 11	2 - 8	3/8"	318	12.52	0.6	1.23
YT-300	12701912	no	5 - 34	4 - 24	3/8"	422	16.60	0.6	1.57
YTR-100	12701911	yes	2.5 - 11	2 - 8	3/8"	334	12.52	0.7	1.23
YTR-300	12701913	yes	5 - 34	4 - 24	3/8"	443	17.00	0.8	1.62
YTR-600	12701914	yes	12 - 68	10 - 50	3/8"	499	19.50	1.1	2.35

**Technical data model YT and model YTR 1/2"**

Model	Art.-No.	Ratchet	Torque		Square drive inch	Length		Weight	
			Nm	Ft.lbs		mm	inch	kg	lbs
YT-600	12701915	no	12 - 68	10 - 50	1/2"	476	18.74	1.0	2.25
YT-1200	12701916	no	25 - 135	20 - 100	1/2"	546	21.50	1.6	3.57
YT-2000	12701369	no	50 - 225	40 - 160	1/2"	597	23.50	2.4	5.25
YT-3000	12701380	no	70 - 330	50 - 250	1/2"	825	32.48	3.1	6.86
YTR-1200	12701368	yes	25 - 135	20 - 100	1/2"	555	21.85	2.0	4.40
YTR-2000	12700544	yes	50 - 225	40 - 160	1/2"	626	24.64	2.5	5.47
YTR-3000	12700545	yes	70 - 330	50 - 250	1/2"	840	33.07	4.0	8.80

**Technical data model YT and model YTR 3/4"**

Model	Art.-No.	Ratchet	Torque		Square drive inch	Length		Weight	
			Nm	Ft.lbs		mm	inch	kg	lbs
YT-5000	12701917	no	140 - 560	100 - 410	3/4"	1130	44.49	5.9	13.00
YT-7200	12701918	no	200 - 810	150 - 600	3/4"	1181	46.50	6.5	14.30
YTR-5000	12700546	yes	140 - 560	100 - 410	3/4"	1210	47.64	6.6	14.50
YTR-7200	12700547	yes	200 - 810	150 - 600	3/4"	1261	49.65	7.0	15.40
YTR-8400	12700548	yes	480 - 940	350 - 700	3/4"	1471	57.91	12.7	28.00

**Technical data model YT, model YTR, model YQW and model YQW-R 1"**

Model	Art.-No.	Ratchet	Torque		Square drive inch	Length		Weight	
			Nm	Ft.lbs		mm	inch	kg	lbs
YT-8400	12701919	no	480 - 940	350 - 700	1"	1397	55.00	11.3	24.90
YT-12300	12701920	no	700 - 1400	500 - 1000	1"	1505	59.25	15.5	34.10
YTR-12300	12700549	yes	700 - 1400	500 - 1000	1"	1505	59.25	17.0	37.40
YQW-10	12701921	no	1015 - 1900	750 - 1400	1"	1356	53.38	16.5	36.30
YQW-11	12701922	no	1350 - 2700	1000 - 2000	1"	1498	58.97	19.5	42.90
YQW-R-10	12700550	yes	1015 - 1900	750 - 1400	1"	1356	53.38	18.0	39.60
YQW-R-11	12700551	yes	1350 - 2700	1000 - 2000	1"	1498	58.97	20.6	45.32



## Hydraulic bolt tensioner model YST

For tightening and loosening stud sizes from 3/4" to 5 3/4" (M16 to M150)

Each load cell cylinder can be used for different stud sizes by simply changing the adaptor-kit, consisting of a threaded puller, bridge and nut driver.

### Features

- High tensioning force, compact design and low self-weight.
- By applying only axial pulling force a torsional loading of the fasteners is avoided. In contrast to the use of hydraulic torque wrenches an axial pulling force is applied in order to avoid torsional loading of the fastener.
- Any number of bolt tensioners can be connected and used simultaneously to ensure equal tightening of all bolts (for example at flange applications).
- Special steel alloy housing for longer lifetime.
- Piston with maximum pulling force, also at 2° tilt without any loss of load. Easy handling through stroke indicator.
- The cylinder is manufactured from high strength alloy steel leadig to increased reliability and compact design. Increased corrosion resistance through hard chrome plated finish.
- The bridge is provided with opening of sufficient width to enable access to 2 holes in the nut simultaneously.
- Nut driver to screw down the nut after tensioning. Holes are provided for the use of a tommy bar.
- Coupling adaptor without using bonded washers or thread sealing tapes to avoid leakages and provide easy maintenance.
- Non-drip quick-connect couplers assure safe operation. 2 quick connect male nipples allow fast and easy connection for multiple tensioning.
- Special seals for leakage free working. Easy change of seals in case of maintenance.

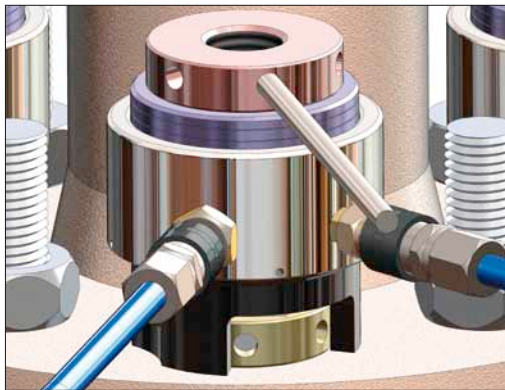



## Technical data model YST and adapter kits model YST-A metric

Load cell	EAN-No. 4025092*	Adapter kits	EAN-No. 4025092*	Bolt size mm	Capacity KN	Hydr. area mm <sup>2</sup>	Ø mm	A mm	B mm	C mm	D mm	Weight* kg
YST-01	*486675	YST-A1-M20	*486729	20	339	2257	84	76	145	26	47	3.6
		YST-A1-M24	*486774	24				84	153	30	54	3.7
YST-02	*486996	YST-A2-M27	*487016	27	397	2649	98	88	157	29	56	4.5
		YST-A2-M30	*487078	30				89	162	32	62	4.7
		YST-A2-M33	*487122	33				91	168	35	68	4.9
		YST-A2-M36	*487160	36				93	174	38	73	5.1
YST-03	*487399	YST-A3-M33	*487429	33	639	4259	115	92	162	37	70	6.1
		YST-A3-M36	*487443	36				94	167	40	75	6.6
		YST-A3-M39	*487467	39				98	175	43	80	6.7
YST-04	*487559	YST-A4-M36	*487573	36	721	4808	128	94	167	41	76	8.1
		YST-A4-M39	*487597	39				98	172	43	81	8.4
		YST-A4-M42	*487610	42				100	176	46	86	8.4
		YST-A4-M45	*487634	45				101	181	49	91	8.5
YST-05	*487733	YST-A5-M42	*487825	42	942	6280	145	102	184	47	87	11.6
		YST-A5-M45	*487870	45				106	190	50	93	11.8
		YST-A5-M48	*487917	48				109	196	53	98	12.0
		YST-A5-M52	*487979	52				109	201	56	105	13.3
YST-06	*488372	YST-A6-M48	*488433	48	1354	9028	165	109	194	54	99	15.1
		YST-A6-M52	*488501	52				112	199	57	106	15.6
		YST-A6-M56	*488525	56				116	208	61	113	15.8
		YST-A6-M60	*488563	60				117	209	61	114	15.8
YST-07	*488792	YST-A7-M56	*488822	56	1651	11006	180	117	205	59	112	18.1
		YST-A7-M60	*488860	60				122	214	61	117	18.3
		YST-A7-M64	*488945	64				125	221	66	125	18.6
		YST-A7-M68	*488969	68				130	231	66	129	18.9
YST-08	*489188	YST-A8-M64	*489232	64	1978	13188	198	127	226	70	129	23.4
		YST-A8-M68	*489256	68				132	233	69	132	23.5
		YST-A8-M72	*489294	72				135	240	75	141	23.7
YST-09	*489478	YST-A9-M72	*489553	72	2257	16485	215	137	241	75	141	29.6
		YST-A9-M76	*489577	76				141	249	80	150	30.2
		YST-A9-M80	*489638	80				141	255	80	150	30.2
YST-10	*489850	YST-A10-M80	*489874	80	3047	20312	244	152	258	87	160	40.1
		YST-A10-M85	*489935	85				154	264	87	164	40.6
		YST-A10-M90	*490061	90				158	269	93	175	40.7
		YST-A10-M95	*490108	95				164	280	93	179	40.9
		YST-A10-M100	*490191	100				171	293	105	195	50.2
YST-11	*490498	YST-A11-M100	*490535	100	3768	25120	280	174	289	106	196	52.7
		YST-A11-M110	*490580	110				181	305	111	210	57.7
		YST-A11-M120	*490634	120				193	198	118	226	62.7
		YST-A11-M125	*490672	125				197	338	121	233	64.6
YST-12	*490900	YST-A12-M125	*490931	125	4754	31694	325	199	346	124	236	89.6
		YST-A12-M130	*490993	130				202	354	126	243	93.2
		YST-A12-M140	*491044	140				212	372	135	260	100.7
		YST-A12-M150	*491099	150				216	388	141	275	103.3

\*Indicates weight of load cell and adapter-kit of particular size

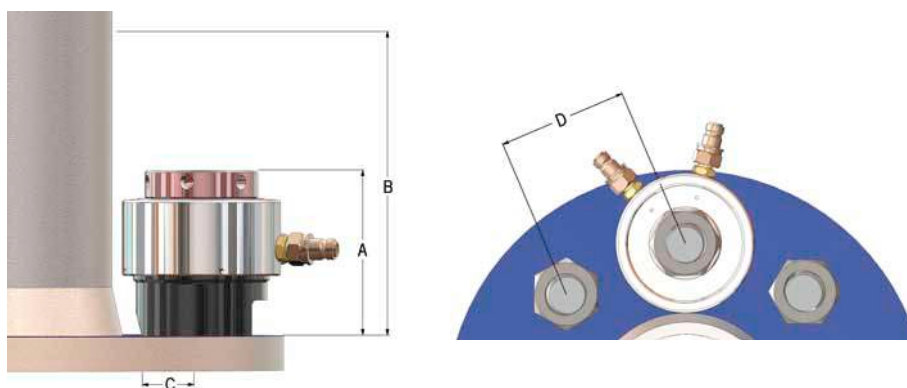

**!** Special sizes are available on request

## Technical data model YST and adapter kits model YST-A imperial

Load cell	EAN-No. 4025092*	Adapter kits	EAN-No. 4025092*	Bolt size inch	Capacity KN	Hydr. area inch	Ø inch	A inch	B inch	C inch	D inch	Weight* lbs
YST-01	*486675	YST-A1-0.12	*486699	3/4	339	3.50	3.31	3.00	5.71	1.02	1.81	7.72
		YST-A1-0.14	*486743	7/8				3.31	6.02	1.18	2.09	8.16
		YST-A1-1.00	*486859	1				3.31	6.02	1.18	2.17	8.16
YST-02	*486996	YST-A2-1.02	*487030	1 1/8	397	2.649	2.68	3.46	6.18	1.14	2.20	9.92
		YST-A2-1.04	*487085	1 1/4				3.58	6.57	1.38	2.64	10.58
		YST-A2-1.06	*487146	1 3/8				3.66	6.81	1.50	2.83	11.25
YST-03	*487399	YST-A3-1.04	*487412	1 1/4	639	4.259	4.53	3.62	6.38	1.46	2.72	13.01
		YST-A3-1.06	*487436	1 3/8				3.70	6.54	1.57	2.91	14.55
		YST-A3-1.08	*487450	1 1/2				3.86	6.89	1.69	3.15	14.77
YST-04	*487559	YST-A4-1.06	*487566	1 3/8	721	4.808	5.04	3.70	6.57	1.61	2.95	16.98
		YST-A4-1.08	*487580	1 1/2				3.85	6.77	1.69	3.19	17.86
		YST-A4-1.10	*487603	1 5/8				3.94	6.77	1.81	3.39	18.52
		YST-A4-1.12	*487627	1 3/4				3.98	6.97	1.93	3.58	18.74
YST-05	*487733	YST-A5-1.10	*487795	1 5/8	942	6.280	5.71	4.02	7.17	1.85	3.43	25.14
		YST-A5-1.12	*487849	1 3/4				4.17	7.44	1.97	3.62	26.02
		YST-A5-1.14	*487887	1 7/8				4.29	7.72	2.07	3.86	26.46
		YST-A5-2.00	*487955	2				4.29	7.91	2.20	4.09	28.00
YST-06	*488372	YST-A6-1.14	*488402	1 7/8	1354	9.028	6.50	4.29	7.64	2.13	3.89	32.63
		YST-A6-2.00	*488457	2				4.41	7.83	2.24	4.13	34.40
		YST-A6-2.04	*488549	2 1/4				4.57	8.23	2.40	4.49	34.84
YST-07	*488792	YST-A7-2.04	*488846	2 1/4	1651	17.06	7.09	4.61	8.15	2.32	4.41	40.13
		YST-A7-2.08	*488884	2 1/2				4.92	8.70	2.59	4.92	41.01
		YST-A7-2.12	*488976	2 3/4				5.27	9.33	2.83	5.35	42.77
YST-08	*489188	YST-A8-2.08	*489218	2 1/2	1978	20.44	7.80	5.00	8.89	2.76	5.08	51.38
		YST-A8-2.12	*489270	2 3/4				5.19	9.25	2.95	5.47	52.26
YST-09	*489478	YST-A9-2.12	*489515	2 3/4	2257	23.30	8.46	5.39	9.49	2.95	5.47	64.60
		YST-A9-3.00	*489614	3				5.55	10.04	3.15	5.91	66.59
		YST-A9-3.04	*489652	3 1/4				5.55	10.04	3.15	5.91	66.59
YST-10	*489850	YST-A10-3.04	*489898	3 1/4	3047	31.48	9.61	5.98	10.28	3.43	6.38	88.86
		YST-A10-3.08	*489959	3 1/2				6.22	10.55	3.66	6.85	89.74
		YST-A10-3.12	*490122	3 3/4				6.46	11.02	4.13	7.52	110.25
		YST-A10-4.00	*490214	4				6.73	11.53	4.13	7.75	110.69
YST-11	*490498	YST-A11-3.12	*490511	3 3/4	3768	38.94	11.02	6.57	11.10	4.17	7.56	116.20
		YST-A11-4.00	*490559	4				6.85	11.45	4.17	7.79	116.20
		YST-A11-4.04	*490573	4 1/4				7.12	11.97	4.37	8.23	127.23
		YST-A11-4.08	*490610	4 1/2				7.32	12.44	4.64	8.74	134.50
		YST-A11-4.12	*490658	4 3/4				7.75	13.15	4.76	9.02	140.24
YST-12	*490900	YST-A12-5.00	*490962	5	4754	49.13	12.79	7.83	13.82	5.08	9.56	199.33
		YST-A12-5.04	*491013	5 1/4				8.07	14.05	5.31	10.00	205.50
		YST-A12-5.08	*491037	5 1/2				8.35	14.64	5.55	10.47	221.60
		YST-A12-5.3/4	*491075	5 3/4				8.38	15.00	5.70	10.86	222.26

\*Indicates weight of load cell and adapter-kit of particular size

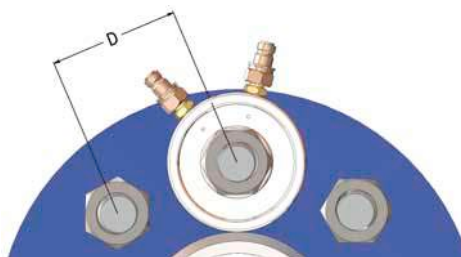
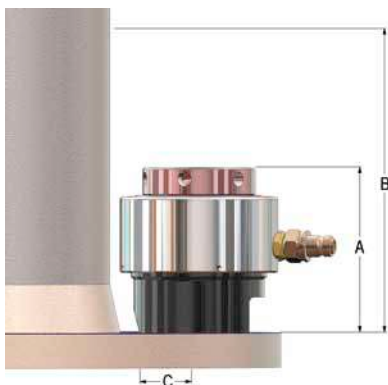

**Special sizes are available on request**

**Hydraulic bolt tensioners**  
**model YDA 700 bar**  
**model YWM 1500 bar**

Especially for applications in windmill-industry we introduced the 2 series YDA (working pressure 700 bar) and YWM (1500 bar).

Bolt-tensioners of series YDA are often used for tightening of foundation-bolts. Tensioners of series YWM for other applications in wind-industry, for example for assembly of rotor-blades.

The surfaces of cylinders are hard chrome plated for better corrosion resistance on outdoor applications.



**Technical data model YDA**

Model	Art.-No.	Bolt size	Capacity kN	Diameter max.		Stroke		Dimension C		Length		Weight	
				mm	inch	mm	inch	mm	inch	mm	inch	kg	lbs
YDA-3336	12701923	M33 - M36	385	116	4.56	25	0.98	54	2.13	138	5.43	4.3	9.48
YDA-3033	12701924	M30 - M33	357	102	4.01	25	0.98	49	1.93	138	5.43	5.2	11.44

**Technical data model YWM**

Model	Art.-No.	Bolt size	Capacity kN	Diameter max.		Stroke standard		Stroke long	
				mm	inch	mm	inch	mm	inch
YWM-18	12701925	M16 - M18	114	53	2.08	10	0.39	-	-
YWM-22	12701926	M20 - M22	188	64	2.52	10	0.39	-	-
YWM-27	12701927	M24 - M27	271	74	2.91	15	0.59	25	0.98
YWM-33	12701928	M30 - M33	369	86	3.38	15	0.59	25	0.98
YWM-39	12701929	M36 - M39	458	97	3.81	15	0.59	25	0.98



Model YWM with auto-retraction



Model YWM without auto-retraction

## Hydraulic bolt tensioners model YSS

For stud sizes from 3/4" to 3 1/2" (M18 to M90),

for subsea and offshore applications

- Special stainless steel alloy housing for longer lifetime
- Tool consists of two basic parts, tensioning unit and puller nut for easy handling.
- High tensioning force, compact design and low self-weight.
- Each load cell cylinder can be used for different stud sizes by simply changing the adaptor-kit, consisting of threaded puller, bridge and nut driver.

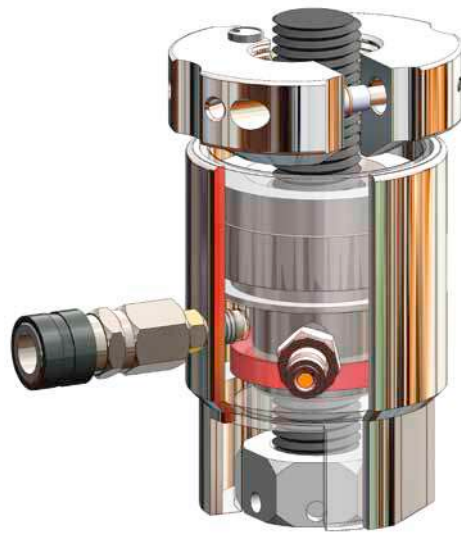

**Optional split nut for fast and easy fitment**



### Technical data model YSS metric

Load cell	Art.-No.	Puller	Art.-No.	Bolt size mm	Capacity		Hydr. area mm <sup>2</sup>	A mm	B mm	C mm	D mm	E mm	Weight kg
					t	KN							
YSS-01	12701723	YSS-PT01-M20	12701725	M20	21.2	188	1256	122	65	30	100	46	2.3
YSS-02	12701723	YSS-PT02-M24	12701731	M24	34.7	309	2061	153	83	30	123	64	4.0
		YSS-PT02-M27	12701733	M27									4.0
		YSS-PT02-M30	12701735	M30									4.0
YSS-03	12701741	YSS-PT03-M33	12701743	M33	54.2	482	3215	171	98	30	138	78	5.5
		YSS-PT03-M36	12701745	M36									5.5
YSS-04	12701750	YSS-PT04-M39	12701752	M39	79.4	706	4710	186	113	30	147	93	7.4
		YSS-PT04-M42	12701754	M42									7.4
YSS-05	12701759	YSS-PT05-M45	12701761	M45	119.1	1060	7065	197	136	60	152	113	13.5
		YSS-PT05-M48	12701763	M48									13.5
		YSS-PT05-M52	12701765	M52									13.8
YSS-06	12701772	YSS-PT06-M56	12701773	M56	174.7	1554	10362	229	162	60	171	141	20.7
		YSS-PT06-M60	12701775	M60									20.7
		YSS-PT06-M64	12701777	M64									20.9
YSS-07	12701783	YSS-PT07-M72	12701785	M72	219.4	1952	13011	266	190	60	194	166	23.5
		YSS-PT07-M76	12701786	M76									23.5
YSS-08	12701792	YSS-PT08-M80	12701793	M80	268.7	2390	15935	288	214	60	208	191	31.5
		YSS-PT08-M85	12701795	M85									31.5
		YSS-PT08-M90	12701801	M90									31.5

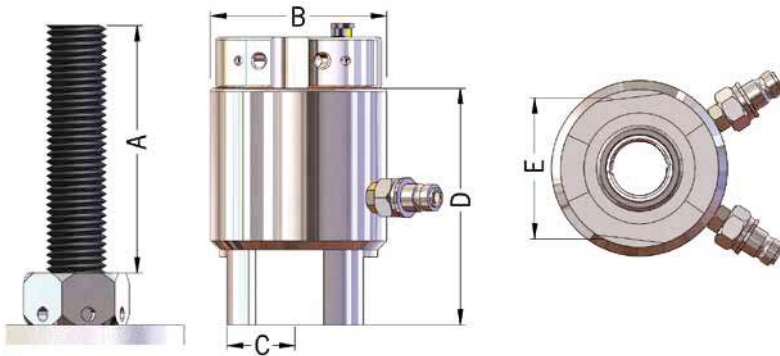

Technical data model YSS imperial

Load cell	Art.-No.	Puller	Art.-No.	Bolt size inch	Max. load		Hydr. area in <sup>2</sup>	A inch	B inch	C inch	D inch	E inch	Weight lbs	
					t	KN								
YSS-01	12701723	YSS-PT01-0.12	12701724	3/4	21.2	188	1.95	4.80	2.56	1.18	3.93	1.81	5.07	
		YSS-PT01-0.14	12701726	7/8										5.07
YSS-02	12701723	YSS-PT02-1.00	12701732	1	34.7	309	3.19	6.02	3.27	1.18	4.84	2.52	8.82	
		YSS-PT02-1.02	12701734	1 1/8										8.82
YSS-03	12701741	YSS-PT03-1.04	12701742	1 1/4	54.2	482	4.98	6.73	3.85	1.18	5.43	3.07	12.13	
		YSS-PT03-1.06	12701744	1 3/8										12.13
YSS-04	12701750	YSS-PT04-1.08	12701751	1 1/2	79.4	706	7.30	7.32	4.44	1.18	5.78	3.66	16.32	
		YSS-PT04-1.10	12701753	1 5/8										16.32
YSS-05	12701759	YSS-PT05-1.12	12701760	1 3/4	119.1	1060	10.95	7.75	5.35	2.36	5.98	4.44	29.77	
		YSS-PT05-1.14	12701762	1 7/8										29.77
		YSS-PT05-2.00	12701764	2										30.43
YSS-06	12701772	YSS-PT06-2.04	12701774	2 1/4	174.7	1554	16.06	9.02	6.38	2.36	6.73	5.55	45.64	
		YSS-PT06-2.08	12701776	2 1/2										46.08
YSS-07	12701783	YSS-PT07-2.12	12701784	2 3/4	219.4	1952	20.17	10.47	7.48	2.36	7.64	6.54	51.82	
		YSS-PT07-3.00	12701787	3										51.82
YSS-08	12701792	YSS-PT08-3.04	12701794	3 1/4	268.7	2390	24.70	11.39	8.43	2.36	8.19	7.52	69.46	
		YSS-PT08-3.08	12701796	3 1/2										69.46

## Hydraulic bolt tensioners model CST

Bolt tensioners for friction-less and torsion-free tightening and loosening.

- Leight-weight and compact design, high tensioning forces for small outer dimensions.
- No torsional loading , only real pulling force.
- Manufactured from high grade alloy steel for longer lifetime.
- Each cylinder covers different stud sizes, only 6 different sizes cover stud-sizes from M20 to M64.

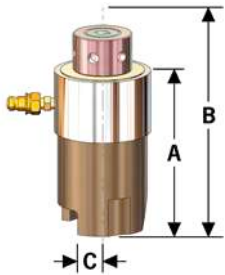

### Technical data model CST metric

Load cell	Art.-No.	Adapter kits	Art.-No.	Bolt size mm	Capacity kN oder KN	Hydr. area mm <sup>2</sup>	Diameter mm	Pitch min. mm	A mm	B mm	C mm
CST-01	12701816	CST-A1-M20	12701818	M20	235.1	1568	68	43	173	193	38
		CST-A1-M24	12701820	M24				46	177	201	44
		CST-A1-M27	12701822	M27				49	180	207	50
CST-02	12701829	CST-A2-M30	12701831	M30	423.2	2822	88	55	241	271	55
		CST-A2-M33	12701883	M33				57	244	277	60
		CST-A2-M36	12701885	M36				61	247	283	65
CST-03	12701892	CST-A3-M36	12701893	M36	531.6	3545	103	76	267	303	65
		CST-A3-M39	12701895	M39				79	270	309	70
		CST-A3-M42	12701897	M42				82	273	315	75
CST-04	12701851	CST-A4-M42	12701852	M42	752.7	5019	118	92	296	338	75
		CST-A4-M45	12701854	M45				94	299	344	81
		CST-A4-M48	12701856	M48				97	302	350	86
CST-05	12701862	CST-A5-M48	12701863	M48	926.2	6176	130	104	327	375	86
		CST-A5-M52	12701865	M52				107	331	383	93
		CST-A5-M56	12701866	M56				109	335	391	100
CST-06	12701873	CST-A6-M60	12701875	M60	1261.6	8413	148	120	370	430	107
		CST-A6-M64	12701877	M64				124	374	438	113

### Technical data model CST imperial

Load cell	Art.-No.	Adapter kits	Art.-No.	Bolt size inch	Capacity kN oder KN	Hydr. area in <sup>2</sup>	Diameter inch	Pitch min. inch	A inch	B inch	C inch
CST-01	12701816	CST-A1-0.12	12701817	3/4	235.1	2.43	2.68	1.65	6.81	7.56	1.46
		CST-A1-0.14	12701819	7/8				1.73	6.89	7.76	1.61
		CST-A1-1.00	12701821	1				1.85	7.00	7.99	1.81
CST-02	12701829	CST-A2-1.02	12701830	1 1/8	423.2	4.37	3.46	2.08	9.45	10.59	2.09
		CST-A2-1.04	12701832	1 1/4				2.20	9.56	10.79	2.28
		CST-A2-1.06	12701884	1 3/8				2.32	9.69	11.06	2.48
CST-03	12701892	CST-A3-1.08	12701894	1 1/2	531.6	5.49	4.06	2.99	10.51	11.93	2.56
		CST-A3-1.10	12701896	1 5/8				3.19	10.70	12.36	2.91
CST-04	12701851	CST-A4-1.12	12701853	1 3/4	752.7	7.78	4.65	3.66	11.73	13.50	3.14
		CST-A4-1.14	12701855	1 7/8				3.70	11.77	13.54	3.19
CST-05	12701862	CST-A5-2.00	12701864	2	926.2	9.57	5.12	4.17	12.99	15.00	3.38
		CST-A5-2.04	12701867	2 1/4				4.29	13.22	15.47	4.01
CST-06	12701873	CST-A6-2.04	12701874	2 1/4	1261.6	13.04	5.82	4.60	14.44	16.69	4.01
		CST-A6-2.08	12701876	2 1/2				4.76	14.72	17.20	4.44

**Selection chart hydraulic pumps – Nut splitters**

Model	Oil volume cm <sup>3</sup>	Hand pumps					Foot pump FPS-2/0,5A	Mini hydraulic pumps	
		single-stage	two-stage					PAY-6	PAY-6-5
		HPS-1/0,7 A 700 cm <sup>3</sup>	HPS-2/0,7 A 700 cm <sup>3</sup>	HPS-2/2 A 2000 cm <sup>3</sup>	HPS-2/4 A 4000 cm <sup>3</sup>	HPS-2/6,5 A 6500 cm <sup>3</sup>			
YNS-AH1324	120	+++	+++	-	-	-	+++	+++	-
YNS-AH1636	300	+++	+++	+++	-	-	+++	+++	-
YNS-AH3651	300	+++	+++	+++	-	-	+++	+++	-
YNS-AH4660	1100	-	-	+++	-	-	-	+++	-
YNS-AH5770	1100	-	-	+++	-	-	-	+++	-
YNS-AH7089	2200	-	-	-	+++	+++	-	-	+++
YNS-AH7998	2200	-	-	-	+++	+++	-	-	+++
YNS-95108	3000	-	-	-	+++	+++	-	-	+++
YNS-114127	3000	-	-	-	+++	+++	-	-	+++
YNS-124136	3000	-	-	-	+++	+++	-	-	+++

+++ recommended hand pump

++ these combinations can also be used, but the oil volume of the hand pump is quite small

- these combinations should not be chosen, because the oil volumes of the hand pumps are too small to fill the selected cylinder (too large and bulky, respectively)

**Selection chart hydraulic pumps – Flange spreaders**

Model	Oil volume cm <sup>3</sup>	Hand pumps					Foot pump FPS-2/0,5A	Mini hydraulic pumps	
		single-stage	two-stage					PAY-6	PAY-6-5
		HPS-1/0,7 A 700 cm <sup>3</sup>	HPS-2/0,7 A 700 cm <sup>3</sup>	HPS-2/2 A 2000 cm <sup>3</sup>	HPS-2/4 A 4000 cm <sup>3</sup>	HPS-2/6,5 A 6500 cm <sup>3</sup>			
FS-10H	47	+++	+++	-	-	-	+++	+++	-
FS-5T	25	+++	+++	-	-	-	+++	+++	-
FS-10T	78	+++	+++	++	-	-	+++	+++	-

+++ recommended hand pump

++ these combinations can also be used, but the oil volume of the hand pump is quite small

- these combinations should not be chosen, because the oil volumes of the hand pumps are too small to fill the selected cylinder (too large and bulky, respectively)

**Selection chart hydraulic pumps – Flange spreaders/Lifting wedge**

Model	Oil volume cm <sup>3</sup>	Hand pumps					Foot pump FPS-2/0,5A	Mini hydraulic pumps	
		single-stage	two-stage					PAY-6	PAY-6-5
		HPS-1/0,7 A 700 cm <sup>3</sup>	HPS-2/0,7 A 700 cm <sup>3</sup>	HPS-2/2 A 2000 cm <sup>3</sup>	HPS-2/4 A 4000 cm <sup>3</sup>	HPS-2/6,5 A 6500 cm <sup>3</sup>			
YSW-14T	78	+++	+++	++	-	-	+++	+++	-
HK-16T	78	+++	+++	++	-	-	+++	+++	-

+++ recommended hand pump

++ these combinations can also be used, but the oil volume of the hand pump is quite small

- these combinations should not be chosen, because the oil volumes of the hand pumps are too small to fill the selected cylinder (too large and bulky, respectively)



## Hand pumps for single-acting cylinders model HPS

Hand pumps are easy to use and operate independently of any external energy source. They are designed for a maximum 700 bar system pressure and will allow each hydraulic cylinder to utilize its maximum capacity.

### Features

- Operating pressure max. 700 bar.
- Two-stage operation with automatic switch-over (except HPS-1/0,7 A).
- Large reservoir volumes.
- With pressure relief valves, adjustable from the outside.
- Precision-adjustable relief valve (handwheel).
- Robust all-steel construction.
- HPH pumps are equipped with a 4-way control valve plus a precision-adjustable relief valve.
- Oil port thread 3/8 NPT.
- Incl. oil filling.

Hydraulic hoses for the connection between hand pump and hydraulic cylinders need to be selected separately.

See page 43.

## Technical data model HPS

Model	EAN-No. 4025092*	Displacement	Reservoir volume cm <sup>3</sup>	Displacement 1 <sup>st</sup> stage cm <sup>3</sup>	Displacement 2 <sup>nd</sup> stage cm <sup>3</sup>	Weight kg
HPS-1/0,7 A	*159081	single-stage	700	–	2	7.0
HPS-2/0,7 A	*159098	two-stage	700	11	2	7.0
HPS-2/2 A	*159104	two-stage	2000	11	2	10.0
HPS-2/4 A	*159111	two-stage	4000	11	2	13.0
HPS-2/6,5 A	*159128	two-stage	6500	11	2	21.0

## Dimensions model HPS

Model	HPS-1/0,7 A	HPS-2/0,7 A	HPS-2/2 A	HPS-2/4 A	HPS-2/6,5 A
A, mm	505	505	520	645	645
B, mm	85	85	70	65	65
C, mm	135	135	145	160	215
D, mm	150	150	150	150	180
E, mm	43	43	43	43	43
F, mm	52	52	52	52	52

Dimensions approx.

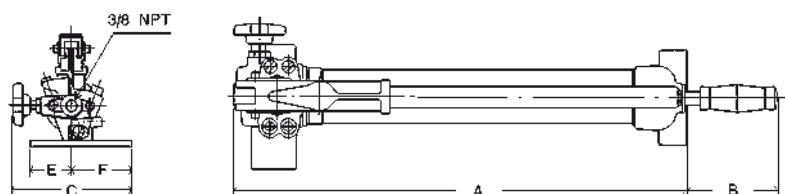



## Foot pump model FPS

### Operating pressure 700 bar

Used to operate single-acting hydraulic cylinders, especially for repeated applications, where it is necessary to keep hands free.

### Features

- Operating pressure max. 700 bar.
- Absolute stability due to large base plate.
- Minimized labour fatigue.
- Operating pressure adjustable. Valves accessible from the outside.
- Return stroke of cylinder also controlled by foot operation.
- Oil port 3/8 NPT.



### Technical data model FPS

Model	EAN-No. 4025092*	Operating pressure bar	Displacement 1 <sup>st</sup> stage cm <sup>3</sup>	Displacement 2 <sup>nd</sup> stage cm <sup>3</sup>	Reservoir volume useable cm <sup>3</sup>	Weight kg
FPS-2/0,5 A	*160155	700	11	2	500	7

## Hydraulic spreader model YHS

### Capacity max. 0.5 - 1.5 t

These universal power tools can be used for all repair, maintenance and assembly work requiring precisely controlled power, e.g. aligning of containers and shells, lifting, positioning or aligning of machinery and structural components, forcing-off of shutterings and moulds. Applications are unlimited. The spreaders can be operated with all hand pumps.



### Features

- Operating pressure max. 700 bar.
- Single-acting with spring return.
- Works in all positions.
- Spreader arms of high-tensile steel.
- Incl. female coupler half CFY-1 with dust cap.

### Technical data model YHS

Model	EAN-No. 4025092*	Capacity max. kN	Capacity max. t	Operating pressure max. bar	Oil volume max. cm <sup>3</sup>	Spread width min. mm	Spread width max. mm	Weight kg
YHS-05	*157650	5	0.5	700	10	16	75	1.9
YHS-11	*154741	10	1.0	700	10	14	100	2.1
YHS-15	*154673	15	1.5	700	70	35	220	6.9



## Mini hydraulic pumps model PAY

### With compressed air driven motor 700 bar

These mini-pumps are driven by an air-powered motor and can be connected to any supply source of compressed air. These compact low-cost pumps can operate all single-acting or double-acting hydraulic cylinders up to a max. operating pressure of 700 bar.

Due to large reservoirs, large cylinders or multiple cylinders can be operated. The use of an inline air filter-lubricator is recommended.

### Technical data model PAY

Model	EAN-No. 4025092*	For cylinders	Reservoir volume l	Oil pressure max. bar	Oil-displacement l/min	Required air pressure bar	Air consumption l/min	Oil port	Air port	Weight kg
PAY-6	*153270	single-acting	1.5	700	0.85 up to 0.08	7	560	3/8 NPT	1/4 NPT	6.3
PAY-6-5	*160735	single-acting	5.0	700	0.85 up to 0.08	7	560	3/8 NPT	1/4 NPT	12.0



## Manifolds model MY

### With shut-off valve, 700 bar

Manifolds with shut-off valves are used when different pressures must be maintained in each hydraulic line and therefore allow the lifting of unequal loads. The manifolds are fully assembled and can be screwed directly to a hand pump or power pack. Depending on the way of assembly a short hose HHC-10 and a coupler half CFY-1 can be helpful.

Manifolds models MY ... GYA are equipped with the corresponding number of shut-off valves plus pressure gauge sets (GYA-63) which allow a permanent reading of each individual load.

### Technical data model MY

Model	EAN-No. 4025092*	Version	Weight kg
MY-22	*155045	Manifold with 2 shut-off valves	1.8
MY-44	*155052	Manifold with 4 shut-off valves	3.7
MY-66	*159517	Manifold with 6 shut-off valves	5.5
MY-22-GYA	*159210	Manifold with 2 shut-off valves and 2 pressure gauges	2.8
MY-44-GYA	*159227	Manifold with 4 shut-off valves and 4 pressure gauges	5.7
MY-66-GYA	*159524	Manifold with 6 shut-off valves and 6 pressure gauges	8.5

## Pressure gauge model GYA-63

Consisting of pressure gauge GGY-632 (diameter Ø 63 mm, glycerine-damped) and corresponding gauge adapter. This pressure gauge set is suitable for connection to all HPS hand pumps.



### Technical data model GYA-63

Model	EAN-No. 4025092*	Pressure gauge bar	Oil port pump	Oil port hose	Weight kg
GYA-63	*156103	0 - 1000 bar, Ø 63 mm, glycerine-damped	3/8-NPT outer	3/8-NPT inner	0.5

## Hydraulic hoses model HHC

Durable but highly flexible thermoplast hydraulic hoses guarantee a very long life.

The 4-layer build-up includes 2 layers of high tensile steel fabric and robust fitting with 19 mm hexagon.

The volumetric expansion is very low. Hydraulic hoses model HHC...are equipped with a male coupler half as standard.



### Technical data model HHC

Model	EAN-No. 4025092*	Length m	NW mm	Operating pressure bar	Burst pressure bar	Connection 2 male coupler half CMY-1	Connection 1 thread nipple 3/8-NPT, outer	External diameter approx. mm	Bend radius min. mm	Width mm
HHC-5	*155786	0.5	6.3	700	2800			14	100	6.3
HHC-10	*155687	1	6.3	700	2800			14	100	6.3
HHC-20	*155380	2	6.3	700	2800			14	100	6.3
HHC-30	*155793	3	6.3	700	2800			14	100	6.3
HHC-40	*155397	4	6.3	700	2800			14	100	6.3
HHC-60	*155595	6	6.3	700	2800			14	100	6.3
HHC-80	*155731	8	6.3	700	2800			14	100	6.3
HHC-100	*155809	10	6.3	700	2800			14	100	6.3
HHC-120	*156370	12	6.3	700	2800			14	100	6.3
HHC-150	*156387	15	6.3	700	2800			14	100	6.3



## Impact sockets model YS-...

### -long version model YSL-...

- All Impact Sockets are made from high strength alloy steel.
- Sizes available up to 225 mm across the flats
- Square-drives 1/2", 3/4", 1", 1 1/2", 2 1/2"
- All Impact Sockets have a Ring-N-Pin arrangement for securing them to the drive.
- Freecorner-profiles for the transmission of energy on the surface rather than the edges, leading to increased lifetime of socket and nut.

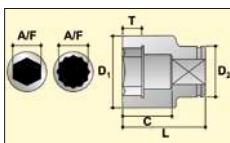

### Technical data model YS 3/4"- drive standard length metric

Width across flats AF mm	Model	EAN-No. 4025092*	Diameter ØD1 mm	Diameter ØD2 mm	T mm	C mm	Length mm	Weight kg
19	YS-3/4-SW19	*491402	32	42	12	21	45	0.3
21	YS-3/4-SW21	*491426	36	42	13	24	48	0.3
22	YS-3/4-SW22	*491464	37	42	13	24	48	0.3
23	YS-3/4-SW23	*491488	39	42	13	24	48	0.4
24	YS-3/4-SW24	*491518	39	42	15	24	48	0.3
26	YS-3/4-SW26	*491556	41	44	15	24	48	0.4
27	YS-3/4-SW27	*491570	44	44	16	24	48	0.4
28	YS-3/4-SW28	*491594	44	44	16	24	48	0.4
30	YS-3/4-SW30	*491617	47	44	18	27	51	0.4
32	YS-3/4-SW32	*491631	49	44	18	27	51	0.5
33	YS-3/4-SW33	*491655	50	44	18	27	51	0.5
34	YS-3/4-SW34	*491679	52	44	20	30	54	0.5
36	YS-3/4-SW36	*491693	54	54	20	30	54	0.6
38	YS-3/4-SW38	*491716	57	54	23	35	59	0.8
41	YS-3/4-SW41	*491785	61	54	23	35	59	0.8
42	YS-3/4-SW42	*491815	62	54	25	35	59	0.8
43	YS-3/4-SW43	*491846	63	54	25	38	62	0.9
46	YS-3/4-SW46	*491853	67	54	25	38	62	0.9
50	YS-3/4-SW50	*491907	70	54	28	41	65	1.0

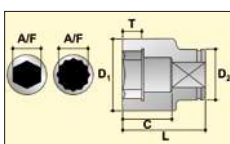

### Technical data model YS 3/4"- drive long version metric

Width across flats AF mm	Model	EAN-No. 4025092*	Diameter ØD1 mm	Diameter ØD2 mm	T mm	C mm	Length mm	Weight kg
19	YSL-3/4-SW19	*494823	32	42	12	61	85	0.5
21	YSL-3/4-SW21	*494854	36	42	13	61	85	0.5
22	YSL-3/4-SW22	*494861	37	42	13	61	85	0.6
23	YSL-3/4-SW23	*494915	39	42	13	61	85	0.6
24	YSL-3/4-SW24	*494939	40	42	15	61	85	0.6
26	YSL-3/4-SW26	*494991	41	42	15	66	90	0.6
27	YSL-3/4-SW27	*495028	43	43	16	66	90	0.7
28	YSL-3/4-SW28	*495042	44	44	16	66	90	0.7
30	YSL-3/4-SW30	*495066	47	44	18	66	90	0.8
32	YSL-3/4-SW32	*495110	49	44	18	66	90	0.8
33	YSL-3/4-SW33	*495158	50	44	18	66	90	0.8
34	YSL-3/4-SW34	*495172	52	44	20	66	90	0.9
36	YSL-3/4-SW36	*495257	54	54	20	66	90	1.0
38	YSL-3/4-SW38	*495325	57	54	23	66	90	1.1
41	YSL-3/4-SW41	*495370	61	54	23	66	90	1.2
42	YSL-3/4-SW42	*495400	62	54	25	66	90	1.2
43	YSL-3/4-SW43	*495424	63	54	25	66	90	1.3
46	YSL-3/4-SW46	*495448	67	54	25	76	100	1.6
50	YSL-3/4-SW50	*495462	70	54	28	76	100	1.6

Technical data model YS 1"- drive standard length metric

Width across flats AF mm	Model	EAN-No. 4025092*	Diameter Ø D1 mm	Diameter Ø D2 mm	T mm	C mm	Length mm	Weight kg
19	YS-1-SW19	*491969	36	51	14	25	55	0.5
20	YS-1-SW20	*491990	36	51	14	25	55	0.5
21	YS-1-SW21	*492010	38	51	14	25	55	0.5
22	YS-1-SW22	*492041	40	51	14	25	55	0.5
23	YS-1-SW23	*492065	40	51	14	25	55	0.5
24	YS-1-SW24	*492089	42	51	16	27	57	0.6
25	YS-1-SW25	*492102	43	51	16	27	57	0.6
26	YS-1-SW26	*492133	45	51	16	27	57	0.6
27	YS-1-SW27	*492157	46	51	16	27	57	0.6
28	YS-1-SW28	*492188	47	51	16	27	57	0.6
29	YS-1-SW29	*492201	48	51	18	29	59	0.6
30	YS-1-SW30	*492232	49	54	18	29	59	0.7
31	YS-1-SW31	*492263	50	54	18	29	59	0.7
32	YS-1-SW32	*492287	52	54	18	29	59	0.7
33	YS-1-SW33	*492300	54	54	18	29	59	0.7
34	YS-1-SW34	*492317	54	54	20	31	61	0.7
35	YS-1-SW35	*492324	54	54	20	31	61	0.7
36	YS-1-SW36	*492331	57	54	20	31	61	0.8
37	YS-1-SW37	*492348	57	54	20	31	61	0.8
38	YS-1-SW38	*492355	59	54	22	34	64	0.8
39	YS-1-SW39	*492362	60	54	22	34	64	0.8
40	YS-1-SW40	*492379	60	54	22	34	64	0.9
41	YS-1-SW41	*492386	62	54	22	34	64	0.9
42	YS-1-SW42	*492393	64	54	24	36	66	1.0
43	YS-1-SW43	*492409	65	54	24	36	66	1.0
44	YS-1-SW44	*492416	66	54	24	36	66	1.0
45	YS-1-SW45	*492423	68	54	24	36	66	1.0
46	YS-1-SW46	*492430	68	54	26	38	68	1.0
47	YS-1-SW47	*492447	71	54	26	38	68	1.1
48	YS-1-SW48	*492454	71	54	26	38	68	1.1
49	YS-1-SW49	*492461	74	54	28	40	70	1.2
50	YS-1-SW50	*492478	74	54	28	40	70	1.2
51	YS-1-SW51	*492485	77	62	28	40	70	1.4
52	YS-1-SW52	*492492	77	62	28	40	70	1.4
54	YS-1-SW54	*492508	79	62	28	40	70	1.4
55	YS-1-SW55	*492515	79	62	30	44	74	1.5
56	YS-1-SW56	*492522	80	62	30	44	74	1.5
57	YS-1-SW57	*492539	84	62	30	44	74	1.6
58	YS-1-SW58	*492546	84	62	30	44	74	1.6
59	YS-1-SW59	*492553	87	62	32	47	77	1.8
60	YS-1-SW60	*492560	87	62	32	47	77	1.8
62	YS-1-SW62	*492577	90	62	34	49	79	1.9
65	YS-1-SW65	*492584	93	62	36	51	81	2.0
70	YS-1-SW70	*492591	99	86	38	54	84	2.8
75	YS-1-SW75	*492607	104	86	40	56	89	3.1
80	YS-1-SW80	*492614	112	86	42	58	91	3.5
85	YS-1-SW85	*492621	119	86	44	60	93	3.9
90	YS-1-SW90	*492638	122	86	46	62	95	3.8
95	YS-1-SW95	*492645	130	106	48	64	97	5.1
100	YS-1-SW100	*492652	134	106	50	66	99	5.2
105	YS-1-SW105	*492669	142	106	52	68	101	5.8
110	YS-1-SW110	*492676	147	106	54	72	105	6.0
115	YS-1-SW115	*492683	153	127	56	72	105	7.4

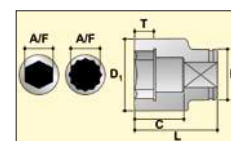

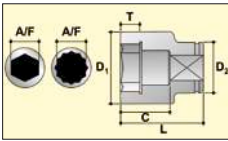

## Technical data model YSL 1"-drive long version metric

Width across flats AF mm	Model	EAN-No. 4025092*	Diameter ØD1 mm	Diameter ØD2 mm	T mm	C mm	Length mm	Weight kg
19	YSL-1-SW19	*495486	36	51	14	72	102	0.8
20	YSL-1-SW20	*495509	36	51	14	72	102	0.8
21	YSL-1-SW21	*495523	38	51	14	72	102	0.8
22	YSL-1-SW22	*495554	40	51	14	72	102	0.9
23	YSL-1-SW23	*495585	40	51	14	72	102	0.8
24	YSL-1-SW24	*495615	42	51	16	72	102	0.9
25	YSL-1-SW25	*495646	43	51	16	72	102	0.9
26	YSL-1-SW26	*495660	45	51	16	72	102	1.0
27	YSL-1-SW27	*495714	46	51	16	72	102	1.0
28	YSL-1-SW28	*495738	47	51	16	72	102	1.0
29	YSL-1-SW29	*495806	48	51	18	72	102	1.0
30	YSL-1-SW30	*495868	49	54	18	72	102	1.1
31	YSL-1-SW31	*495882	50	54	18	72	102	1.1
32	YSL-1-SW32	*495905	52	54	18	72	102	1.1
33	YSL-1-SW33	*495929	54	54	18	72	102	1.2
34	YSL-1-SW34	*495943	54	54	20	72	102	1.2
35	YSL-1-SW35	*495967	54	54	20	72	102	1.1
36	YSL-1-SW36	*495981	57	54	20	69	102	1.3
37	YSL-1-SW37	*496018	57	54	20	69	102	1.3
38	YSL-1-SW38	*496032	59	54	22	69	102	1.4
39	YSL-1-SW39	*496056	60	54	22	69	102	1.4
40	YSL-1-SW40	*496070	60	54	22	69	102	1.4
41	YSL-1-SW41	*496117	62	54	22	69	102	1.5
42	YSL-1-SW42	*496131	64	54	24	69	102	1.5
43	YSL-1-SW43	*496179	66	54	24	69	102	1.6
44	YSL-1-SW44	*496193	66	54	24	69	102	1.6
45	YSL-1-SW45	*496216	68	54	24	69	102	1.7
46	YSL-1-SW46	*496230	68	54	26	69	102	1.6
47	YSL-1-SW47	*496254	71	54	26	67	102	1.7
48	YSL-1-SW48	*496278	71	54	26	67	102	1.7
49	YSL-1-SW49	*496292	74	54	28	80	110	2.0
50	YSL-1-SW50	*496322	74	54	28	80	110	2.0
51	YSL-1-SW51	*496346	77	62	28	75	110	2.2
52	YSL-1-SW52	*496360	77	62	28	75	110	2.2
54	YSL-1-SW54	*496384	79	62	28	75	110	2.3
55	YSL-1-SW55	*496414	79	62	40	75	110	2.2
56	YSL-1-SW56	*496452	80	62	30	75	110	2.2
57	YSL-1-SW57	*496483	84	62	30	75	110	2.4
58	YSL-1-SW58	*496506	84	62	30	75	110	2.4
59	YSL-1-SW59	*496520	87	62	32	80	115	2.7
60	YSL-1-SW60	*496544	87	62	32	80	115	2.7
62	YSL-1-SW62	*496568	90	62	32	80	115	2.9
65	YSL-1-SW65	*496599	93	62	34	80	115	2.9
70	YSL-1-SW70	*496643	99	62	36	85	120	3.3
75	YSL-1-SW75	*496667	104	86	38	85	120	4.2
80	YSL-1-SW80	*496681	112	86	40	85	120	4.7
85	YSL-1-SW85	*496704	119	86	42	90	125	5.3
90	YSL-1-SW90	*496728	122	86	44	90	125	5.2
95	YSL-1-SW95	*496742	130	106	46	95	130	6.9
100	YSL-1-SW100	*496773	134	106	48	95	130	6.9
105	YSL-1-SW105	*496803	142	106	50	95	130	7.6
110	YSL-1-SW110	*496827	147	106	52	105	140	8.4
115	YSL-1-SW115	*496896	153	127	54	105	140	9.8

Technical data model YS 1 1/2"- drive standard length metric

Width across flats AF mm	Model	EAN-No. 4025092*	Diameter Ø D1 mm	Diameter Ø D2 mm	T mm	C mm	Length mm	Weight kg
32	YS-1.1/2-SW32	*492690	58	82	19	33	75	1.9
33	YS-1.1/2-SW33	*492706	59	82	19	33	75	1.9
34	YS-1.1/2-SW34	*492713	60	82	20	33	75	1.9
35	YS-1.1/2-SW35	*492720	62	82	21	35	77	2.0
36	YS-1.1/2-SW36	*492737	63	82	21	35	77	2.0
37	YS-1.1/2-SW37	*492744	64	82	21	35	77	2.0
38	YS-1.1/2-SW38	*492751	65	84	21	35	77	2.1
39	YS-1.1/2-SW39	*492768	67	84	22	36	78	2.1
40	YS-1.1/2-SW40	*492775	68	84	22	36	78	2.1
41	YS-1.1/2-SW41	*492782	69	84	23	37	79	2.1
42	YS-1.1/2-SW42	*492799	70	84	23	37	79	2.2
43	YS-1.1/2-SW43	*492805	71	84	24	38	80	2.2
44	YS-1.1/2-SW44	*492812	73	84	24	38	80	2.2
45	YS-1.1/2-SW45	*492829	74	84	25	39	81	2.2
46	YS-1.1/2-SW46	*492836	75	86	26	40	82	2.4
47	YS-1.1/2-SW47	*492843	77	86	26	40	82	2.4
48	YS-1.1/2-SW48	*492850	78	86	26	40	82	2.4
49	YS-1.1/2-SW49	*492867	79	86	27	41	83	2.4
50	YS-1.1/2-SW50	*492874	80	86	27	41	83	2.4
51	YS-1.1/2-SW51	*492898	81	86	27	41	83	2.4
52	YS-1.1/2-SW52	*492928	82	86	28	42	84	2.5
54	YS-1.1/2-SW54	*492942	84	86	28	42	84	2.5
55	YS-1.1/2-SW55	*492973	86	86	29	43	85	2.5
56	YS-1.1/2-SW56	*493024	88	86	29	43	85	2.7
57	YS-1.1/2-SW57	*493055	88	86	29	43	85	2.7
58	YS-1.1/2-SW58	*493079	90	86	30	44	86	2.8
59	YS-1.1/2-SW59	*493109	90	86	32	46	88	2.8
60	YS-1.1/2-SW60	*493123	90	86	32	46	88	2.8
61	YS-1.1/2-SW61	*493192	94	86	32	46	88	3.0
62	YS-1.1/2-SW62	*493222	94	86	32	46	88	2.9
65	YS-1.1/2-SW65	*493260	98	86	34	48	90	3.0
67	YS-1.1/2-SW67	*493284	101	86	36	50	92	3.3
70	YS-1.1/2-SW70	*493321	104	86	38	53	95	3.4
73	YS-1.1/2-SW73	*493345	108	86	40	55	97	3.7
75	YS-1.1/2-SW75	*493369	111	86	42	59	101	4.0
76	YS-1.1/2-SW76	*493383	118	86	44	61	103	4.4
80	YS-1.1/2-SW80	*493406	118	86	44	61	103	4.4
85	YS-1.1/2-SW85	*493420	124	86	48	66	108	4.9
86	YS-1.1/2-SW86	*493444	124	86	50	68	110	4.8
90	YS-1.1/2-SW90	*493468	130	106	53	71	113	6.2
95	YS-1.1/2-SW95	*493499	135	106	56	74	116	6.6
100	YS-1.1/2-SW100	*493512	143	106	59	77	119	7.5
105	YS-1.1/2-SW105	*493536	148	106	62	82	124	7.9
110	YS-1.1/2-SW110	*493567	154	106	65	85	127	8.5
115	YS-1.1/2-SW115	*493574	161	127	68	88	130	10.5
120	YS-1.1/2-SW120	*493598	168	127	71	91	133	11.4
125	YS-1.1/2-SW125	*493611	174	127	74	96	138	12.3

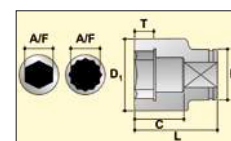

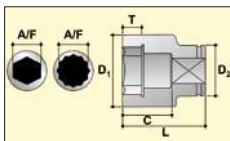

## Technical data model YSL 1 1/2"- drive long version metric

Width across flats AF mm	Model	EAN-No. 4025092*	Diameter ØD1 mm	Diameter ØD2 mm	T mm	C mm	Length mm	Weight kg
32	YSL-1.1/2-SW32	*496919	58	82	19	78	120	2.6
33	YSL-1.1/2-SW33	*496926	59	82	19	78	120	2.6
34	YSL-1.1/2-SW34	*496957	60	82	20	78	120	2.6
35	YSL-1.1/2-SW35	*496988	62	82	21	78	120	2.7
36	YSL-1.1/2-SW36	*497008	63	82	21	78	120	2.7
37	YSL-1.1/2-SW37	*497015	64	82	21	78	120	2.7
38	YSL-1.1/2-SW38	*497060	65	82	21	78	120	2.7
39	YSL-1.1/2-SW39	*497084	67	84	22	78	120	2.9
40	YSL-1.1/2-SW40	*497114	68	84	22	78	120	2.9
41	YSL-1.1/2-SW41	*497121	69	84	23	83	125	3.0
42	YSL-1.1/2-SW42	*497152	70	84	23	83	125	3.1
43	YSL-1.1/2-SW43	*497176	71	84	24	83	125	3.1
44	YSL-1.1/2-SW44	*497183	73	84	24	83	125	3.2
45	YSL-1.1/2-SW45	*497237	74	84	25	83	125	3.2
46	YSL-1.1/2-SW46	*497244	75	86	26	83	125	3.3
47	YSL-1.1/2-SW47	*497268	77	86	26	83	125	3.4
48	YSL-1.1/2-SW48	*497282	78	86	26	83	125	3.4
49	YSL-1.1/2-SW49	*497305	79	86	27	83	125	3.4
50	YSL-1.1/2-SW50	*497312	80	86	27	83	125	3.4
51	YSL-1.1/2-SW51	*497480	81	86	27	83	125	3.5
52	YSL-1.1/2-SW52	*497527	82	86	28	88	130	3.7
54	YSL-1.1/2-SW54	*497541	84	86	28	88	130	3.7
55	YSL-1.1/2-SW55	*497572	86	86	29	88	130	3.8
56	YSL-1.1/2-SW56	*497596	88	86	29	88	130	4.1
57	YSL-1.1/2-SW57	*497619	88	86	29	88	130	4.1
58	YSL-1.1/2-SW58	*497671	90	86	30	88	130	4.0
59	YSL-1.1/2-SW59	*497695	90	86	32	88	130	4.0
60	YSL-1.1/2-SW60	*497763	94	86	32	88	130	4.4
61	YSL-1.1/2-SW61	*497787	94	86	32	88	130	4.4
62	YSL-1.1/2-SW62	*497800	99	86	34	98	140	5.1
65	YSL-1.1/2-SW65	*497831	101	86	36	98	140	5.1
67	YSL-1.1/2-SW67	*497855	101	86	36	98	140	5.1
70	YSL-1.1/2-SW70	*497879	104	86	38	98	140	5.2
73	YSL-1.1/2-SW73	*497886	109	86	40	98	140	3.7
75	YSL-1.1/2-SW75	*497909	111	86	42	108	150	6.3
76	YSL-1.1/2-SW76	*497923	118	86	44	108	150	6.3
80	YSL-1.1/2-SW80	*497947	118	86	44	108	150	6.8
85	YSL-1.1/2-SW85	*497978	124	86	48	118	160	7.8
86	YSL-1.1/2-SW86	*497992	124	86	50	118	160	7.6
90	YSL-1.1/2-SW90	*498012	130	106	53	128	170	9.7
95	YSL-1.1/2-SW95	*498029	135	106	56	128	170	9.8
100	YSL-1.1/2-SW100	*498036	143	106	59	128	170	11.0
105	YSL-1.1/2-SW105	*498043	148	106	62	138	180	12.0
110	YSL-1.1/2-SW110	*498067	154	106	65	138	180	12.6
115	YSL-1.1/2-SW115	*498098	161	127	68	138	180	14.7
120	YSL-1.1/2-SW120	*498111	167	127	71	148	190	16.3
125	YSL-1.1/2-SW125	*498135	174	127	74	148	190	17.4



Technical data model YS 2 1/2"- drive standard length metric

Width across flats AF mm	Model	EAN-No. 4025092*	Diameter Ø D1 mm	Diameter Ø D2 mm	T mm	C mm	Length mm	Weight kg
43	YS-2.1/2-SW43	*493659	86	116	28	46	104	5.2
44	YS-2.1/2-SW44	*493673	86	116	28	46	104	5.2
45	YS-2.1/2-SW45	*493697	86	116	28	46	104	5.2
46	YS-2.1/2-SW46	*493727	86	116	28	46	104	5.1
47	YS-2.1/2-SW47	*493741	86	116	28	46	104	5.1
48	YS-2.1/2-SW48	*493789	86	116	28	46	104	5.0
49	YS-2.1/2-SW49	*493826	86	116	28	46	104	5.0
50	YS-2.1/2-SW50	*493840	86	116	28	46	104	4.9
51	YS-2.1/2-SW51	*493857	90	116	29	46	104	5.1
52	YS-2.1/2-SW52	*493888	90	116	29	46	104	5.0
54	YS-2.1/2-SW54	*493901	93	124	30	46	104	5.9
55	YS-2.1/2-SW55	*493925	94	124	32	52	110	6.1
56	YS-2.1/2-SW56	*493949	95	124	32	52	110	6.1
57	YS-2.1/2-SW57	*493970	96	124	32	52	110	6.1
58	YS-2.1/2-SW58	*493994	98	124	32	52	110	6.1
59	YS-2.1/2-SW59	*494014	99	127	34	54	112	6.6
60	YS-2.1/2-SW60	*494045	100	127	36	56	114	6.6
62	YS-2.1/2-SW62	*494052	103	127	36	56	114	6.7
65	YS-2.1/2-SW65	*494076	106	127	38	58	116	6.8
67	YS-2.1/2-SW67	*494090	109	127	38	58	116	6.9
70	YS-2.1/2-SW70	*494106	113	127	40	60	118	7.1
73	YS-2.1/2-SW73	*494137	116	127	40	60	118	7.1
75	YS-2.1/2-SW75	*494151	119	127	42	64	122	7.4
76	YS-2.1/2-SW76	*494175	120	127	44	64	122	7.4
80	YS-2.1/2-SW80	*494199	125	127	44	64	122	7.5
85	YS-2.1/2-SW85	*494212	129	127	48	68	126	8.1
86	YS-2.1/2-SW86	*494236	132	127	50	68	129	8.6
90	YS-2.1/2-SW90	*494250	136	127	52	70	130	8.9
95	YS-2.1/2-SW95	*494274	142	127	54	72	132	9.4
100	YS-2.1/2-SW100	*494298	148	127	56	78	138	10.2
105	YS-2.1/2-SW105	*494311	154	127	60	82	142	11.0
110	YS-2.1/2-SW110	*494342	161	127	64	86	146	11.9
115	YS-2.1/2-SW115	*494366	165	127	67	89	149	12.2
120	YS-2.1/2-SW120	*494380	173	127	70	92	152	13.3
125	YS-2.1/2-SW125	*494403	179	127	73	95	153	13.7
130	YS-2.1/2-SW130	*494427	185	127	76	98	156	14.5
135	YS-2.1/2-SW135	*494441	192	152	79	103	161	18.4
140	YS-2.1/2-SW140	*494465	196	152	82	106	164	18.6
145	YS-2.1/2-SW145	*494472	204	152	85	109	167	20.2
150	YS-2.1/2-SW150	*494502	211	152	88	112	170	21.4
155	YS-2.1/2-SW155	*494526	215	152	91	117	175	22.0
160	YS-2.1/2-SW160	*494540	223	152	94	120	178	23.9
165	YS-2.1/2-SW165	*494564	229	175	96	122	180	27.2
170	YS-2.1/2-SW170	*494588	235	175	98	126	184	28.9
175	YS-2.1/2-SW175	*494601	242	175	100	128	186	30.2
180	YS-2.1/2-SW180	*494625	246	175	103	131	189	30.3
185	YS-2.1/2-SW185	*494649	254	175	106	134	192	32.5
190	YS-2.1/2-SW190	*494663	261	175	109	137	195	34.0
195	YS-2.1/2-SW195	*494700	265	175	112	142	200	34.8
200	YS-2.1/2-SW200	*494724	273	175	115	145	203	37.5
210	YS-2.1/2-SW210	*494748	285	175	120	150	208	39.9
215	YS-2.1/2-SW215	*494762	292	175	123	153	211	41.9
225	YS-2.1/2-SW225	*494786	304	175	130	160	218	45.7

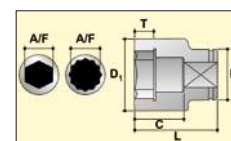

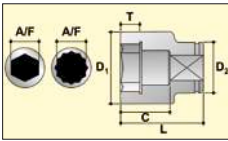

## Technical data model YSL 2 1/2"- drive long version metric

Width across flats AF mm	Model	EAN-No. 4025092*	Diameter ØD1 mm	Diameter ØD2 mm	T mm	C mm	Length mm	Weight kg
43	YSL-2.1/2-SW43	*498173	86	106	26	110	168	6.4
44	YSL-2.1/2-SW44	*498197	86	106	26	110	168	6.4
45	YSL-2.1/2-SW45	*498210	86	106	26	110	168	6.3
46	YSL-2.1/2-SW46	*498234	86	106	27	110	168	6.2
47	YSL-2.1/2-SW47	*498258	86	106	28	110	168	6.1
48	YSL-2.1/2-SW48	*498272	86	116	28	110	168	7.0
49	YSL-2.1/2-SW49	*498289	86	116	28	110	168	7.0
50	YSL-2.1/2-SW50	*498319	86	116	29	110	168	6.9
51	YSL-2.1/2-SW51	*498333	90	116	29	110	168	7.2
52	YSL-2.1/2-SW52	*498364	90	116	29	110	168	7.2
54	YSL-2.1/2-SW54	*498388	93	124	30	110	168	8.1
55	YSL-2.1/2-SW55	*498418	94	124	32	110	168	8.2
56	YSL-2.1/2-SW56	*498449	95	124	32	117	175	8.5
57	YSL-2.1/2-SW57	*498463	96	124	32	117	175	8.6
58	YSL-2.1/2-SW58	*498494	98	124	32	117	175	8.7
59	YSL-2.1/2-SW59	*498531	99	127	34	117	175	9.0
60	YSL-2.1/2-SW60	*498548	100	127	36	117	175	9.1
62	YSL-2.1/2-SW62	*498562	103	127	36	127	185	9.7
65	YSL-2.1/2-SW65	*498586	106	127	38	127	185	9.9
67	YSL-2.1/2-SW67	*498609	109	127	38	127	185	10.1
70	YSL-2.1/2-SW70	*498623	113	127	40	127	185	10.4
73	YSL-2.1/2-SW73	*498654	116	127	40	127	185	10.6
75	YSL-2.1/2-SW75	*498678	119	127	42	127	185	10.8
76	YSL-2.1/2-SW76	*498692	120	127	44	127	185	10.9
80	YSL-2.1/2-SW80	*498715	125	127	44	127	185	11.2
85	YSL-2.1/2-SW85	*498739	129	127	48	137	195	12.4
86	YSL-2.1/2-SW86	*498753	132	127	50	134	195	13.0
90	YSL-2.1/2-SW90	*498777	136	127	52	135	195	13.4
95	YSL-2.1/2-SW95	*498869	142	127	54	139	199	14.5
100	YSL-2.1/2-SW100	*498883	148	127	56	135	195	15.1
105	YSL-2.1/2-SW105	*498906	154	127	60	145	205	16.3
110	YSL-2.1/2-SW110	*498920	161	127	64	149	109	17.7
115	YSL-2.1/2-SW115	*498944	165	127	67	150	210	17.7
120	YSL-2.1/2-SW120	*498968	173	127	70	150	210	19.2
125	YSL-2.1/2-SW125	*498982	179	127	73	157	215	20.6
130	YSL-2.1/2-SW130	*499002	185	127	76	157	215	21.4
135	YSL-2.1/2-SW135	*499026	192	152	79	162	220	25.7
140	YSL-2.1/2-SW140	*499040	196	152	82	167	225	26.2
145	YSL-2.1/2-SW145	*499064	204	152	85	172	230	28.8
150	YSL-2.1/2-SW150	*499088	211	152	88	172	230	30.4
155	YSL-2.1/2-SW155	*499101	215	152	91	177	235	31.0
160	YSL-2.1/2-SW160	*499132	223	152	94	177	235	33.5
165	YSL-2.1/2-SW165	*499156	229	175	96	182	240	37.5
170	YSL-2.1/2-SW170	*499170	235	175	98	182	240	39.2
175	YSL-2.1/2-SW175	*499231	242	175	100	182	240	40.9
180	YSL-2.1/2-SW180	*499255	246	175	103	187	245	41.6
185	YSL-2.1/2-SW185	*499293	254	175	106	192	250	45.6
190	YSL-2.1/2-SW190	*499316	261	175	109	192	250	46.9
195	YSL-2.1/2-SW195	*499330	265	175	112	199	257	48.3
200	YSL-2.1/2-SW200	*499361	273	175	115	202	260	51.9
210	YSL-2.1/2-SW210	*499385	285	175	120	202	260	54.7
215	YSL-2.1/2-SW215	*499408	292	175	123	212	270	59.4
225	YSL-2.1/2-SW225	*499439	304	175	130	220	270	62.4

Technical data model YS 3/4"- drive standard length imperial

Width across flats AF inch	Model	EAN-No. 4025092*	Diameter Ø D1 inch	Diameter Ø D2 inch	T inch	C inch	Length inch	Weight lbs
9/16	YS-3/4-SW9/16	*512848	1.131	1.654	0.472	0.827	1.772	0.620
5/8	YS-3/4-SW5/8	*512862	1.181	1.654	0.472	0.827	1.772	0.670
11/16	YS-3/4-SW11/16	*512886	1.211	1.654	0.472	0.827	1.772	0.690
3/4	YS-3/4-SW3/4	*512909	1.260	1.654	0.472	0.827	1.772	0.670
13/16	YS-3/4-SW13/16	*512923	1.417	1.654	0.512	0.945	1.890	0.740
7/8	YS-3/4-SW7/8	*512961	1.535	1.654	0.512	0.945	1.890	0.770
15/16	YS-3/4-SW15/16	*512985	1.535	1.654	0.591	0.945	1.890	0.750
1	YS-3/4-SW1	*513012	1.614	1.732	0.591	0.945	1.890	0.830
1-1/16	YS-3/4-SW1-1/16	*513067	1.732	1.732	0.630	0.945	1.890	0.870
1-1/8	YS-3/4-SW1-1/8	*513081	1.850	1.732	0.709	1.063	2.008	0.970
1-3/16	YS-3/4-SW1-3/16	*513104	1.880	1.732	0.709	1.063	2.008	0.970
1-1/4	YS-3/4-SW1-1/4	*513111	1.929	1.732	0.709	1.063	2.008	1.000
1-5/16	YS-3/4-SW1-5/16	*513142	2.047	1.732	0.787	1.181	2.126	1.120
1-3/8	YS-3/4-SW1-3/8	*513173	2.076	2.126	0.787	1.181	2.126	1.400
1-7/16	YS-3/4-SW1-7/16	*513180	2.106	2.126	0.787	1.181	2.126	1.400
1-1/2	YS-3/4-SW1-1/2	*513227	2.344	2.126	0.906	1.378	2.323	1.660
1-9/16	YS-3/4-SW1-9/16	*513333	2.352	2.126	0.906	1.378	2.323	1.760
1-5/8	YS-3/4-SW1-5/8	*513357	2.441	2.126	0.984	1.378	2.323	1.790
1-11/16	YS-3/4-SW1-11/16	*513371	2.480	2.126	0.984	1.496	2.441	1.900
1-3/4	YS-3/4-SW1-3/4	*513401	2.688	2.126	0.984	1.496	2.441	2.070
1-13/16	YS-3/4-SW1-13/16	*513425	2.688	2.126	0.984	1.496	2.441	2.070
1-7/8	YS-3/4-SW1-7/8	*513500	2.706	2.126	1.102	1.614	2.559	2.130
2	YS-3/4-SW2	*513524	2.981	2.441	1.181	1.732	2.677	2.780

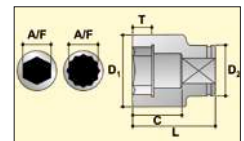

Technical data model YS 3/4"- drive long version imperial

Width across flats AF inch	Model	EAN-No. 4025092*	Diameter Ø D1 inch	Diameter Ø D2 inch	T inch	C inch	Length inch	Weight lbs
9/16	YSL-3/4-SW9/16	*514842	1.131	1.654	0.472	2.402	3.346	0.970
5/8	YSL-3/4-SW5/8	*514873	1.181	1.654	0.472	2.402	3.346	1.020
11/16	YSL-3/4-SW11/16	*514903	1.211	1.654	0.472	2.402	3.346	1.040
3/4	YSL-3/4-SW3/4	*514927	1.260	1.654	0.472	2.402	3.346	1.050
13/16	YSL-3/4-SW13/16	*521574	1.417	1.654	0.512	2.402	3.346	1.190
7/8	YSL-3/4-SW7/8	*521581	1.535	1.654	0.512	2.402	3.346	1.290
15/16	YSL-3/4-SW15/16	*521598	1.575	1.654	0.591	2.402	3.346	1.310
1	YSL-3/4-SW1	*521659	1.614	1.654	0.591	2.598	3.543	1.360
1-1/16	YSL-3/4-SW1-1/16	*521758	1.693	1.693	0.630	2.598	3.543	1.480
1-1/8	YSL-3/4-SW1-1/8	*521772	1.850	1.732	0.709	2.598	3.543	1.690
1-3/16	YSL-3/4-SW1-3/16	*521789	1.880	1.732	0.709	2.598	3.543	1.710
1-1/4	YSL-3/4-SW1-1/4	*521826	1.929	1.732	0.709	2.598	3.543	1.760
1-5/16	YSL-3/4-SW1-5/16	*521833	2.047	1.732	0.787	2.598	3.543	1.910
1-3/8	YSL-3/4-SW1-3/8	*521857	2.126	2.126	0.787	2.598	3.543	2.280
1-7/16	YSL-3/4-SW1-7/16	*521871	2.156	2.126	0.787	2.598	3.543	2.300
1-1/2	YSL-3/4-SW1-1/2	*521901	2.244	2.126	0.906	2.598	3.543	2.470
1-9/16	YSL-3/4-SW1-9/16	*521925	2.402	2.126	0.906	2.598	3.543	2.700
1-5/8	YSL-3/4-SW1-5/8	*521949	2.441	2.126	0.984	2.598	3.543	2.730
1-11/16	YSL-3/4-SW1-11/16	*521963	2.480	2.126	0.984	2.598	3.543	2.760
1-3/4	YSL-3/4-SW1-3/4	*521987	2.638	2.126	0.984	2.992	3.937	3.440
1-13/16	YSL-3/4-SW1-13/16	*522014	2.456	2.126	1.102	2.992	3.937	3.410
1-7/8	YSL-3/4-SW1-7/8	*522090	2.456	2.126	1.102	2.992	3.937	3.410
2	YSL-3/4-SW2	*522113	2.731	2.441	1.181	2.992	3.937	4.180

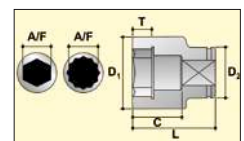

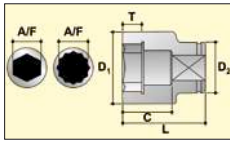

## Technical data model YS 1"- drive standard length imperial

Width across flats AF inch	Model	EAN-No. 4025092*	Diameter ØD1 inch	Diameter ØD2 inch	T inch	C inch	Length inch	Weight lbs
3/4	YS-1-SW3/4	*523431	1.417	2.008	0.551	0.984	2.165	1.13
13/16	YS-1-SW13/16	*523455	1.496	2.008	0.551	0.984	2.165	1.13
7/8	YS-1-SW7/8	*523479	1.575	2.008	0.551	0.984	2.165	1.14
15/16	YS-1-SW15/16	*523509	1.654	2.008	0.630	1.063	2.244	1.20
1	YS-1-SW1	*523547	1.772	2.008	0.630	1.063	2.244	1.24
1-1/16	YS-1-SW1-1/16	*523561	1.811	2.008	0.630	1.063	2.244	1.25
1-1/8	YS-1-SW1-1/8	*523585	1.890	2.008	0.709	1.142	2.323	1.29
1-3/16	YS-1-SW1-3/16	*523592	1.969	2.126	0.709	1.142	2.323	1.45
1-1/4	YS-1-SW1-1/4	*523622	2.047	2.126	0.709	1.142	2.323	1.49
1-5/16	YS-1-SW1-5/16	*523646	2.126	2.126	0.787	1.220	2.402	1.54
1-3/8	YS-1-SW1-3/8	*523660	2.126	2.126	0.787	1.220	2.402	1.51
1-7/16	YS-1-SW1-7/16	*523684	2.244	2.126	0.787	1.220	2.402	1.68
1-1/2	YS-1-SW1-1/2	*523707	2.323	2.126	0.866	1.339	2.520	1.86
1-9/16	YS-1-SW1-9/16	*523714	2.362	2.126	0.866	1.339	2.520	1.88
1-5/8	YS-1-SW1-5/8	*523752	2.520	2.126	0.945	1.417	2.598	2.13
1-11/16	YS-1-SW1-11/16	*523783	2.559	2.126	0.945	1.417	2.598	2.15
1-3/4	YS-1-SW1-3/4	*523813	2.677	2.126	0.945	1.417	2.598	2.27
1-13/16	YS-1-SW1-13/16	*523837	2.677	2.126	1.024	1.496	2.677	2.25
1-7/8	YS-1-SW1-7/8	*523875	2.795	2.126	1.024	1.496	2.677	2.37
1-15/16	YS-1-SW1-15/16	*523899	2.795	2.126	1.024	1.496	2.677	2.37
2	YS-1-SW2	*523929	2.963	2.126	1.102	1.575	2.756	2.67
2-1/16	YS-1-SW2-1/16	*523943	2.963	2.126	1.102	1.575	2.756	2.67
2-1/8	YS-1-SW2-1/8	*523967	3.110	2.441	1.102	1.575	2.756	3.13
2-3/16	YS-1-SW2-3/16	*523998	3.150	2.441	1.181	1.732	2.913	3.21
2-1/4	YS-1-SW2-1/4	*524032	3.307	2.441	1.181	1.732	2.913	3.50
2-5/16	YS-1-SW2-5/16	*524063	3.307	2.441	1.181	1.732	2.913	3.50
2-3/8	YS-1-SW2-3/8	*524094	3.405	2.441	1.260	1.850	3.031	3.77
2-7/16	YS-1-SW2-7/16	*524124	3.543	2.441	1.339	1.929	3.110	4.17
2-1/2	YS-1-SW2-1/2	*524148	3.543	2.441	1.339	1.929	3.110	4.17
2-9/16	YS-1-SW2-9/16	*524216	3.711	2.441	1.417	2.008	3.189	4.38
2-5/8	YS-1-SW2-5/8	*524230	3.711	2.441	1.417	2.008	3.189	4.38
2-11/16	YS-1-SW2-11/16	*524254	3.898	3.386	1.496	2.126	3.307	6.19
2-3/4	YS-1-SW2-3/4	*524278	3.898	3.386	1.496	2.126	3.307	6.19
2-13/16	YS-1-SW2-13/16	*524308	3.898	3.386	1.496	2.126	3.307	6.19
2-7/8	YS-1-SW2-7/8	*524322	4.094	3.386	1.575	2.205	3.504	6.77
2-15/16	YS-1-SW2-15/16	*524360	4.094	3.386	1.575	2.205	3.504	6.77
3	YS-1-SW3	*524438	4.094	3.386	1.575	2.205	3.504	6.77
3-1/16	YS-1-SW3-1/16	*524452	4.425	3.386	1.654	2.283	3.583	7.80
3-1/8	YS-1-SW3-1/8	*524476	4.425	3.386	1.654	2.283	3.583	7.80
3-3/16	YS-1-SW3-3/16	*524490	4.425	3.386	1.654	2.283	3.583	7.80
3-1/4	YS-1-SW3-1/4	*524513	4.651	3.386	1.732	2.362	3.661	8.13
3-5/16	YS-1-SW3-5/16	*524537	4.742	3.386	1.732	2.362	3.661	8.48
3-3/8	YS-1-SW3-3/8	*524599	4.742	3.386	1.732	2.362	3.661	8.48
3-7/16	YS-1-SW3-7/16	*524629	4.803	3.386	1.811	2.441	3.740	8.44
3-1/2	YS-1-SW3-1/2	*524643	4.803	3.386	1.811	2.441	3.740	8.44
3-5/8	YS-1-SW3-5/8	*524667	5.118	4.173	1.890	2.520	3.819	11.29
3-3/4	YS-1-SW3-3/4	*524704	5.118	4.173	1.890	2.520	3.819	11.29
3-7/8	YS-1-SW3-7/8	*524742	5.276	4.173	1.969	2.598	3.898	11.44
4	YS-1-SW4	*524766	5.591	4.173	2.047	2.677	3.976	12.82
4-1/8	YS-1-SW4-1/8	*524810	5.591	4.173	2.047	2.677	3.976	12.82
4-1/4	YS-1-SW4-1/4	*524834	5.727	4.173	2.126	2.835	4.134	13.05
4-3/8	YS-1-SW4-3/8	*524865	6.024	5.000	2.205	2.835	4.134	16.20
4-1/2	YS-1-SW4-1/2	*524872	6.024	5.000	2.205	2.835	4.134	16.20

Technical data model YSL 1"- drive long version imperial

Width across flats AF inch	Model	EAN-No. 4025092*	Diameter Ø D1 inch	Diameter Ø D2 inch	T inch	C inch	Length inch	Weight lbs
3/4	YSL-1-SW3/4	*522137	1.417	2.008	0.551	2.835	4.016	1.73
13/16	YSL-1-SW13/16	*522151	1.496	2.008	0.551	2.835	4.016	1.78
7/8	YSL-1-SW7/8	*522175	1.575	2.008	0.551	2.835	4.016	1.85
15/16	YSL-1-SW15/16	*522199	1.654	2.008	0.630	2.835	4.016	1.95
1	YSL-1-SW1	*522229	1.772	2.008	0.630	2.835	4.016	2.10
1 1/16	YSL-1-SW1-1/16	*522250	1.811	2.008	0.630	2.835	4.016	2.13
1 1/8	YSL-1-SW1-1/8	*522274	1.890	2.008	0.709	2.835	4.016	2.18
1 3/16	YSL-1-SW1-3/16	*522298	1.969	2.126	0.709	2.835	4.016	2.39
1 1/4	YSL-1-SW1-1/4	*522328	2.047	2.126	0.709	2.835	4.016	2.51
1 5/16	YSL-1-SW1-5/16	*522342	2.126	2.126	0.787	2.835	4.016	2.56
1-3/8	YSL-1-SW1-3/8	*522359	2.126	2.126	0.787	2.835	4.016	2.49
1-7/16	YSL-1-SW1-7/16	*522397	2.244	2.126	0.787	2.717	4.016	2.82
1-1/2	YSL-1-SW1-1/2	*522410	2.323	2.126	0.866	2.717	4.016	3.03
1-9/16	YSL-1-SW1-9/16	*522427	2.362	2.126	0.866	2.717	4.016	3.02
1-5/8	YSL-1-SW1-5/8	*522441	2.520	2.126	0.945	2.717	4.016	3.36
1-11/16	YSL-1-SW1-11/16	*522489	2.596	2.126	0.945	2.717	4.016	3.53
1-3/4	YSL-1-SW1-3/4	*522533	2.677	2.126	0.945	2.717	4.016	3.62
1-13/16	YSL-1-SW1-13/16	*522557	2.677	2.126	1.024	2.717	4.016	3.49
1-7/8	YSL-1-SW1-7/8	*522571	2.795	2.126	1.024	2.638	4.016	3.69
1-15/16	YSL-1-SW1-15/16	*522595	2.795	2.126	1.024	2.638	4.016	3.69
2	YSL-1-SW2	*522625	2.963	2.126	1.102	3.150	4.331	4.41
2-1/16	YSL-1-SW2-1/16	*522663	2.923	2.126	1.102	3.150	4.331	4.41
2-1/8	YSL-1-SW2-1/8	*522687	3.110	2.441	1.181	2.953	4.331	4.81
2-3/16	YSL-1-SW2-3/16	*522700	3.150	2.441	1.181	2.953	4.331	4.85
2-1/4	YSL-1-SW2-1/4	*522724	3.307	2.441	1.181	2.953	4.331	5.32
2-5/16	YSL-1-SW2-5/16	*522748	2.598	2.126	0.945	2.717	4.016	5.44
2-3/8	YSL-1-SW2-3/8	*522786	3.405	2.441	1.260	3.150	4.528	6.04
2-7/16	YSL-1-SW2-7/16	*522809	3.543	2.441	1.260	3.150	4.528	6.30
2-1/2	YSL-1-SW2-1/2	*522823	2.796	2.126	1.024	2.638	4.016	6.35
2-9/16	YSL-1-SW2-9/16	*522854	3.741	2.441	1.339	3.150	4.528	6.38
2-5/8	YSL-1-SW2-5/8	*522878	3.741	2.441	1.339	3.150	4.528	6.38
2-11/16	YSL-1-SW2-11/16	*522915	3.031	2.441	1.102	2.953	4.331	6.90
2-3/4	YSL-1-SW2-3/4	*522939	3.898	2.441	1.417	3.346	4.724	7.22
2-13/16	YSL-1-SW2-13/16	*522946	3.898	2.441	1.417	3.346	4.724	7.22
2-7/8	YSL-1-SW2-7/8	*522960	4.094	3.386	1.496	3.346	4.724	9.18
2-15/16	YSL-1-SW2-15/16	*522991	4.094	3.386	4.496	3.346	4.724	9.18
3	YSL-1-SW3	*523004	4.094	3.386	1.496	3.346	4.724	9.18
3-1/16	YSL-1-SW3-1/16	*523035	4.425	3.386	1.575	3.346	4.724	10.40
3-1/8	YSL-1-SW3-1/8	*523059	4.425	3.386	1.575	3.346	4.724	10.40
3-3/16	YSL-1-SW3-3/16	*523110	4.425	3.386	1.575	3.346	4.727	10.40
3-1/4	YSL-1-SW3-1/4	*523134	4.651	3.386	1.654	3.543	4.921	10.84
3-5/16	YSL-1-SW3-5/16	*523158	4.751	3.386	1.654	3.543	4.921	11.60
3-3/8	YSL-1-SW3-3/8	*523172	4.751	3.386	1.654	3.543	4.921	11.60
3-7/16	YSL-1-SW3-7/16	*523196	4.803	3.386	1.732	3.543	4.921	11.45
3-1/2	YSL-1-SW3-1/2	*523219	4.803	3.386	1.732	3.543	4.921	11.45
3-5/8	YSL-1-SW3-5/8	*523240	5.118	4.173	1.811	3.740	5.118	15.20
3-3/4	YSL-1-SW3-3/4	*523264	5.118	4.173	1.811	3.740	5.118	15.20
3-7/8	YSL-1-SW3-7/8	*523295	5.276	4.173	1.890	3.740	5.118	15.14
4	YSL-1-SW4	*523318	5.591	4.173	1.969	3.740	5.118	16.68
4-1/8	YSL-1-SW4-1/8	*523349	5.591	4.173	1.969	3.740	5.118	16.68
4-1/4	YSL-1-SW4-1/4	*523363	5.787	4.173	2.047	4.134	5.512	18.58
4-3/8	YSL-1-SW4-3/8	*523394	6.024	5.000	2.126	4.134	5.512	21.59
4-1/2	YSL-1-SW4-1/2	*523417	6.024	5.000	2.126	4.134	5.512	21.59

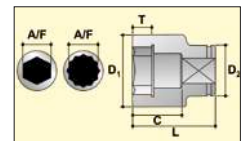

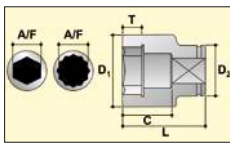

## Technical data model YS 1 1/2"- drive standard length imperial

Width across flats AF inch	Model	EAN-No. 4025092*	Diameter ØD1 inch	Diameter ØD2 inch	T inch	C inch	Length inch	Weight lbs
1-3/8	YS-1-1/2-SW1-3/8	*524902	2.441	3.228	0.827	1.378	3.031	4.30
1-7/16	YS-1-1/2-SW1-7/16	*524926	2.520	3.228	0.827	1.378	3.031	4.30
1-1/2	YS-1-1/2-SW1-1/2	*524940	2.559	3.307	0.827	1.378	3.031	4.60
1-9/16	YS-1-1/2-SW1-9/16	*524964	2.677	3.307	0.866	1.417	3.071	4.70
1-5/8	YS-1-1/2-SW1-5/8	*524988	2.717	3.307	0.906	1.457	3.110	4.70
1-11/16	YS-1-1/2-SW1-11/16	*525008	2.795	3.307	0.945	1.496	3.150	4.80
1-3/4	YS-1-1/2-SW1-3/4	*525046	2.913	3.307	0.984	1.535	3.189	4.90
1-13/16	YS-1-1/2-SW1-13/16	*525060	2.953	3.386	1.024	1.575	3.228	5.20
1-7/8	YS-1-1/2-SW1-7/8	*525121	3.071	3.386	1.024	1.575	3.228	5.30
1-15/16	YS-1-1/2-SW1-15/16	*525145	3.110	3.386	1.063	1.614	3.268	5.30
2	YS-1-1/2-SW2	*525169	3.189	3.386	1.063	1.614	3.268	5.30
2-1/16	YS-1-1/2-SW2-1/16	*525213	3.228	3.386	1.102	1.654	3.307	5.40
2-1/8	YS-1-1/2-SW2-1/8	*525282	3.307	3.386	1.102	1.654	3.307	5.40
2-3/16	YS-1-1/2-SW2-3/16	*525305	3.465	3.386	1.142	1.693	3.346	6.00
2-1/4	YS-1-1/2-SW2-1/4	*525329	3.465	3.386	1.142	1.693	3.346	5.90
2-5/16	YS-1-1/2-SW2-5/16	*525343	3.543	3.386	1.181	1.732	3.386	6.10
2-3/8	YS-1-1/2-SW2-3/8	*525381	3.543	3.386	1.260	1.811	3.465	6.10
2-7/16	YS-1-1/2-SW2-7/16	*525404	3.701	3.386	1.260	1.811	3.465	6.40
2-1/2	YS-1-1/2-SW2-1/2	*525411	3.751	3.386	1.260	1.811	3.465	7.30
2-9/16	YS-1-1/2-SW2-9/16	*525442	3.858	3.386	1.339	1.890	3.543	6.80
2-5/8	YS-1-1/2-SW2-5/8	*525473	3.976	3.386	1.417	1.969	3.622	7.20
2-11/16	YS-1-1/2-SW2-11/16	*525497	4.026	3.386	1.417	1.969	3.622	7.40
2-3/4	YS-1-1/2-SW2-3/4	*525527	4.094	3.386	1.496	2.087	3.740	7.50
2-13/16	YS-1-1/2-SW2-13/16	*525541	4.144	3.386	1.496	2.087	3.740	8.30
2-7/8	YS-1-1/2-SW2-7/8	*525565	4.252	3.386	1.575	2.165	3.819	8.20
2-15/16	YS-1-1/2-SW2-15/16	*525589	4.372	3.386	1.654	2.323	3.976	8.90
3	YS-1-1/2-SW3	*525602	4.420	3.386	1.654	2.323	3.976	9.80
3-1/16	YS-1-1/2-SW3-1/16	*525633	4.646	3.386	1.732	2.402	4.055	9.70
3-1/8	YS-1-1/2-SW3-1/8	*525657	4.646	3.386	1.732	2.402	4.055	9.70
3-3/16	YS-1-1/2-SW3-3/16	*525671	4.716	3.386	1.732	2.402	4.055	10.70
3-1/4	YS-1-1/2-SW3-1/4	*525732	4.716	3.386	1.732	2.402	4.055	10.70
3-5/16	YS-1-1/2-SW3-5/16	*525749	4.882	3.386	1.969	2.677	4.331	10.60
3-3/8	YS-1-1/2-SW3-3/8	*525770	4.882	3.386	1.969	2.677	4.331	10.60
3-7/16	YS-1-1/2-SW3-7/16	*525794	5.118	4.173	2.087	2.795	4.449	13.70
3-1/2	YS-1-1/2-SW3-1/2	*525817	5.118	4.173	2.087	2.795	4.449	13.70
3-9/16	YS-1-1/2-SW3-9/16	*525831	5.193	4.173	2.087	2.795	4.449	13.80
3-5/8	YS-1-1/2-SW3-5/8	*525855	5.193	4.173	2.087	2.795	4.449	13.80
3-11/16	YS-1-1/2-SW3-11/16	*525893	5.315	4.173	2.205	2.913	4.567	17.00
3-3/4	YS-1-1/2-SW3-3/4	*525909	5.315	4.173	2.205	2.913	4.567	17.00
3-13/16	YS-1-1/2-SW3-13/16	*525916	5.670	4.173	2.323	3.031	4.685	17.00
3-7/8	YS-1-1/2-SW3-7/8	*525947	5.670	4.173	2.323	3.031	4.685	17.00
3-15/16	YS-1-1/2-SW3-15/16	*526005	5.745	4.173	2.323	3.031	4.685	17.90
4	YS-1-1/2-SW4	*526029	5.745	4.173	2.323	3.031	4.685	17.90
4-1/16	YS-1-1/2-SW4-1/16	*526043	5.827	4.173	2.441	3.228	4.882	17.40
4-1/8	YS-1-1/2-SW4-1/8	*526067	5.827	4.173	2.441	3.228	4.882	17.40
4-3/16	YS-1-1/2-SW4-3/16	*526081	6.103	4.173	2.559	3.346	5.000	18.70
4-1/4	YS-1-1/2-SW4-1/4	*526159	6.103	4.173	2.559	3.346	5.000	18.70
4-3/8	YS-1-1/2-SW4-3/8	*526173	6.193	4.173	2.559	3.346	5.000	19.70
4-1/2	YS-1-1/2-SW4-1/2	*526210	6.339	5.000	2.677	3.465	5.118	23.00
4-5/8	YS-1-1/2-SW4-5/8	*526227	6.419	5.000	2.677	3.465	5.118	24.20
4-3/4	YS-1-1/2-SW4-3/4	*526296	6.614	5.000	2.795	3.583	5.236	25.00
5	YS-1-1/2-SW5	*526319	6.930	5.000	2.913	3.780	5.433	28.30
5-1/8	YS-1-1/2-SW5-1/8	*526357	7.087	5.000	3.031	3.898	5.551	28.80

Technical data model YSL 1 1/2"- drive long version imperial

Width across flats AF inch	Model	EAN-No. 4025092*	Diameter Ø D1 inch	Diameter Ø D2 inch	T inch	C inch	Length inch	Weight lbs
1-3/8	YSL-1-1/2-SW1-3/8	*526395	2.441	3.228	0.827	3.071	4.724	5.80
1-7/16	YSL-1-1/2-SW1-7/16	*526425	2.520	3.228	0.827	3.071	4.724	5.90
1-1/2	YSL-1-1/2-SW1-1/2	*526470	2.559	3.228	0.827	3.071	4.724	5.90
1-9/16	YSL-1-1/2-SW1-9/16	*526517	2.677	3.307	0.866	3.071	4.724	6.40
1-5/8	YSL-1-1/2-SW1-5/8	*526531	2.717	3.307	0.906	3.268	4.921	6.70
1-11/16	YSL-1-1/2-SW1-11/16	*526555	2.795	3.307	0.945	3.268	4.921	6.80
1-3/4	YSL-1-1/2-SW1-3/4	*526579	2.913	3.307	0.984	3.268	4.921	7.00
1-13/16	YSL-1-1/2-SW1-13/16	*526593	2.953	3.386	1.024	3.268	4.921	7.30
1-7/8	YSL-1-1/2-SW1-7/8	*526616	3.071	3.386	1.024	3.268	4.921	7.50
1-15/16	YSL-1-1/2-SW1-15/16	*526630	3.110	3.386	1.063	3.268	4.921	7.50
2	YSL-1-1/2-SW2	*526654	3.189	3.386	1.063	3.268	4.921	7.60
2-1/16	YSL-1-1/2-SW2-1/16	*526678	3.228	3.386	1.102	3.465	5.118	8.00
2-1/8	YSL-1-1/2-SW2-1/8	*526692	3.307	3.386	1.102	3.465	5.118	8.10
2-3/16	YSL-1-1/2-SW2-3/16	*526722	3.465	3.386	1.142	3.465	5.118	9.10
2-1/4	YSL-1-1/2-SW2-1/4	*526746	3.465	3.386	1.142	3.465	5.118	8.90
2-5/16	YSL-1-1/2-SW2-5/16	*526777	3.543	3.386	1.181	3.465	5.118	9.20
2-3/8	YSL-1-1/2-SW2-3/8	*526791	3.543	3.386	1.260	3.465	5.118	8.90
2-7/16	YSL-1-1/2-SW2-7/16	*526814	3.701	3.386	1.260	3.465	5.118	9.60
2-1/2	YSL-1-1/2-SW2-1/2	*526838	3.751	3.386	1.260	3.465	5.118	10.50
2-9/16	YSL-1-1/2-SW2-9/16	*526869	3.898	3.386	1.339	3.858	5.512	11.10
2-5/8	YSL-1-1/2-SW2-5/8	*526876	3.976	3.386	1.417	3.858	5.512	11.20
2-11/16	YSL-1-1/2-SW2-11/16	*526890	4.026	3.386	1.417	3.858	5.512	11.40
2-3/4	YSL-1-1/2-SW2-3/4	*526944	4.094	3.386	1.496	3.858	5.512	11.50
2-13/16	YSL-1-1/2-SW2-13/16	*526999	4.144	3.386	1.496	3.858	5.512	12.30
2-7/8	YSL-1-1/2-SW2-7/8	*527019	4.291	3.386	1.575	3.858	5.512	12.60
2-15/16	YSL-1-1/2-SW2-15/16	*527033	4.370	3.386	1.654	4.252	5.906	13.80
3	YSL-1-1/2-SW3	*527064	4.420	3.386	1.654	4.252	5.906	14.70
3-1/16	YSL-1-1/2-SW3-1/16	*527088	4.646	3.386	1.732	4.252	5.906	15.00
3-1/8	YSL-1-1/2-SW3-1/8	*527101	4.646	3.386	1.732	4.252	5.906	15.00
3-3/16	YSL-1-1/2-SW3-3/16	*527149	4.716	3.386	1.732	4.252	5.906	16.00
3-1/4	YSL-1-1/2-SW3-1/4	*527187	4.716	3.386	1.732	4.252	5.906	16.00
3-5/16	YSL-1-1/2-SW3-5/16	*527217	4.882	3.386	1.969	4.646	6.299	16.70
3-3/8	YSL-1-1/2-SW3-3/8	*527231	4.882	3.386	1.969	4.646	6.299	16.70
3-7/16	YSL-1-1/2-SW3-7/16	*527255	5.118	4.173	2.087	5.039	6.693	21.30
3-1/2	YSL-1-1/2-SW3-1/2	*527279	5.118	4.173	2.087	5.039	6.693	21.30
3-9/16	YSL-1-1/2-SW3-9/16	*527293	5.193	4.173	2.087	5.039	6.693	21.40
3-5/8	YSL-1-1/2-SW3-5/8	*527316	5.193	4.173	2.087	5.039	6.693	21.40
3-11/16	YSL-1-1/2-SW3-11/16	*527347	5.315	4.173	2.205	5.039	6.693	21.90
3-3/4	YSL-1-1/2-SW3-3/4	*527354	5.315	4.173	2.205	5.039	6.693	21.90
3-13/16	YSL-1-1/2-SW3-13/16	*527385	5.670	4.173	2.323	5.039	6.693	24.90
3-7/8	YSL-1-1/2-SW3-7/8	*527439	5.670	4.173	2.323	5.039	6.693	24.90
3-15/16	YSL-1-1/2-SW3-15/16	*527460	5.745	4.173	2.323	5.039	6.693	25.80
4	YSL-1-1/2-SW4	*527484	5.745	4.173	2.323	5.039	6.693	25.80
4-1/16	YSL-1-1/2-SW4-1/16	*527514	5.827	4.173	2.441	5.433	7.087	26.40
4-1/8	YSL-1-1/2-SW4-1/8	*527521	5.827	4.173	2.441	5.433	7.087	26.40
4-3/16	YSL-1-1/2-SW4-3/16	*527545	6.103	4.173	2.559	5.433	7.087	27.70
4-1/4	YSL-1-1/2-SW4-1/4	*527576	6.103	4.173	2.559	5.433	7.087	27.70
4-3/8	YSL-1-1/2-SW4-3/8	*527637	6.193	4.173	2.559	5.433	7.087	28.70
4-1/2	YSL-1-1/2-SW4-1/2	*527699	6.339	5.000	2.677	5.433	7.087	32.30
4-5/8	YSL-1-1/2-SW4-5/8	*527729	6.575	5.000	2.795	5.827	7.480	35.70
4-3/4	YSL-1-1/2-SW4-3/4	*527750	6.575	5.000	2.795	5.827	7.480	35.70
5	YSL-1-1/2-SW5	*527804	6.930	5.000	2.913	5.827	7.480	39.40
5-1/8	YSL-1-1/2-SW5-1/8	*527859	7.087	5.000	3.031	5.827	7.480	39.90

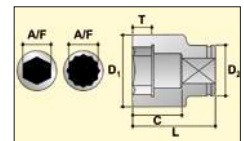

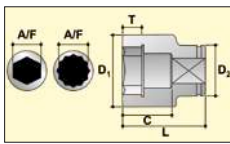

## Technical data model YS 2 1/2"- drive standard length imperial

Width across flats AF inch	Model	EAN-No. 4025092*	Diameter ØD1 inch	Diameter ØD2 inch	T inch	C inch	Length inch	Weight lbs
1 5/8	YS-2.1/2-SW1-5/8	*527897	3.386	4.567	1.102	1.811	4.094	11.30
1 3/4	YS-2.1/2-SW1-3/4	*527910	3.386	4.567	1.102	1.811	4.094	11.30
1 7/8	YS-2.1/2-SW1-7/8	*527941	3.386	4.567	1.102	1.811	4.094	11.30
2	YS-2.1/2-SW2	*527996	3.543	4.567	1.142	1.811	4.094	11.10
2 1/8	YS-2.1/2-SW2-1/8	*528016	3.642	4.882	1.181	1.811	4.094	12.90
2 1/4	YS-2.1/2-SW2-1/4	*528085	3.789	4.882	1.260	2.047	4.331	13.50
2 3/8	YS-2.1/2-SW2-3/8	*528122	3.937	5.000	1.417	2.205	4.488	14.60
2 1/2	YS-2.1/2-SW2-1/2	*528146	4.133	5.000	1.496	2.283	4.567	15.00
2 5/8	YS-2.1/2-SW2-5/8	*528160	4.281	5.000	1.496	2.283	4.567	15.20
2 3/4	YS-2.1/2-SW2-3/4	*528184	4.429	5.000	1.575	2.362	4.646	15.50
2 7/8	YS-2.1/2-SW2-7/8	*528252	4.577	5.000	1.575	2.362	4.646	15.70
2 15/16	YS-2.1/2-SW2-15/16	*528283	4.675	5.000	1.654	2.520	4.803	16.20
3	YS-2.1/2-SW3	*528344	4.774	5.000	1.732	2.520	4.803	16.40
3 1/8	YS-2.1/2-SW3-1/8	*528368	4.921	5.000	1.732	2.520	4.803	16.50
3 1/4	YS-2.1/2-SW3-1/4	*528399	4.999	5.000	1.890	2.677	4.961	16.70
3 3/8	YS-2.1/2-SW3-3/8	*528436	5.197	5.000	1.969	2.677	5.079	18.90
3 1/2	YS-2.1/2-SW3-1/2	*528474	5.354	5.000	2.047	2.756	5.118	19.50
3 5/8	YS-2.1/2-SW3-5/8	*528498	5.394	5.000	2.047	2.756	5.118	20.40
3 3/4	YS-2.1/2-SW3-3/4	*528542	5.591	5.000	2.126	2.835	5.197	20.60
3 7/8	YS-2.1/2-SW3-7/8	*528566	5.787	5.000	2.205	3.071	5.433	21.60
4	YS-2.1/2-SW4	*528597	5.827	5.000	2.205	3.071	5.433	22.40
4 1/8	YS-2.1/2-SW4-1/8	*528610	6.063	5.000	2.362	3.228	5.591	24.20
4 1/4	YS-2.1/2-SW4-1/4	*528634	6.299	5.000	2.520	3.386	5.748	25.50
4 3/8	YS-2.1/2-SW4-3/8	*528658	6.379	5.000	2.520	3.386	5.748	26.40
4 1/2	YS-2.1/2-SW4-1/2	*528672	6.496	5.000	2.638	3.504	5.866	26.80
4 5/8	YS-2.1/2-SW4-5/8	*528702	6.536	5.000	2.638	3.504	5.866	28.00
4 7/8	YS-2.1/2-SW4-7/8	*528726	7.047	5.000	2.874	3.740	6.024	30.10
5	YS-2.1/2-SW5	*528740	7.163	5.000	2.992	3.858	6.142	31.00
5 1/8	YS-2.1/2-SW5-1/8	*528764	7.203	5.000	2.992	3.858	6.142	32.10
5 1/4	YS-2.1/2-SW5-1/4	*528788	7.203	5.000	2.992	3.858	6.142	32.10
5 3/8	YS-2.1/2-SW5-3/8	*528801	7.609	5.984	3.110	4.055	6.339	41.10
5 1/2	YS-2.1/2-SW5-1/2	*528825	7.717	5.984	3.228	4.173	6.457	40.90
5 5/8	YS-2.1/2-SW5-5/8	*528849	7.757	5.984	3.228	4.173	6.457	41.70
5 3/4	YS-2.1/2-SW5-3/4	*528863	8.081	5.984	3.346	4.291	6.575	45.20
6 1/8	YS-2.1/2-SW6-1/8	*528887	9.016	6.890	3.780	4.803	7.087	59.80
6 1/2	YS-2.1/2-SW6-1/2	*528924	9.016	6.890	3.780	4.803	7.087	59.80
6 7/8	YS-2.1/2-SW6-7/8	*528955	9.528	6.890	4.055	5.157	7.441	66.40
7	YS-2.1/2-SW7	*528979	9.685	6.890	4.055	5.157	7.441	66.60
7 1/4	YS-2.1/2-SW7-1/4	*528993	10.000	6.890	4.173	5.276	7.559	71.60
7 1/2	YS-2.1/2-SW7-1/2	*529013	10.276	6.890	4.291	5.394	7.677	74.90
7 5/8	YS-2.1/2-SW7-5/8	*529044	10.433	6.890	4.409	5.591	7.874	76.60
7 3/4	YS-2.1/2-SW7-3/4	*529068	10.433	6.890	4.409	5.591	7.874	76.60
7 7/8	YS-2.1/2-SW7-7/8	*529099	10.748	6.890	4.528	5.709	7.992	82.50
8	YS-2.1/2-SW8	*529136	10.748	6.890	4.528	5.709	7.992	83.60
8 1/8	YS-2.1/2-SW8-1/8	*529150	11.220	6.890	4.724	5.906	8.189	87.80
8 1/4	YS-2.1/2-SW8-1/4	*529174	11.220	6.890	4.724	5.906	8.189	87.80
8 3/8	YS-2.1/2-SW8-3/8	*529198	11.225	6.890	4.724	5.906	8.189	88.70
8 1/2	YS-2.1/2-SW8-1/2	*529211	11.496	6.890	4.843	6.024	8.307	92.30
9	YS-2.1/2-SW9	*529235	12.029	6.890	5.118	6.299	8.583	101.80
9 1/4	YS-2.1/2-SW9-1/4	*529259	12.029	6.890	5.118	6.299	8.583	101.80



Technical data model YSL 2 1/2"- drive long version imperial

Width across flats AF mm	Model	EAN-No. 4025092*	Diameter Ø D1 inch	Diameter Ø D2 inch	T inch	C inch	Length inch	Weight lbs
1 5/8	YSL-2.1/2-SW1-5/8	*529273	3.386	4.173	1.024	4.331	6.614	13.80
1 3/4	YSL-2.1/2-SW1-3/4	*529310	3.386	4.173	1.024	4.331	6.614	13.80
1 7/8	YSL-2.1/2-SW1-7/8	*529334	3.386	4.567	1.102	4.331	6.614	13.80
2	YSL-2.1/2-SW2	*529358	3.543	4.567	1.142	4.331	6.614	15.90
2 1/8	YSL-2.1/2-SW2-1/8	*529372	3.642	4.882	1.181	4.331	6.614	17.80
2 1/4	YSL-2.1/2-SW2-1/4	*529396	3.789	4.882	1.260	4.606	6.890	18.90
2 3/8	YSL-2.1/2-SW2-3/8	*529426	3.937	5.000	1.417	4.606	6.890	20.00
2 1/2	YSL-2.1/2-SW2-1/2	*529440	4.133	5.000	1.496	5.000	7.283	21.80
2 5/8	YSL-2.1/2-SW2-5/8	*529464	4.281	5.000	1.496	5.000	7.283	22.30
2 3/4	YSL-2.1/2-SW2-3/4	*529488	4.429	5.000	1.575	5.000	7.283	22.80
2 7/8	YSL-2.1/2-SW2-7/8	*529501	4.577	5.000	1.575	5.000	7.283	23.40
2 15/16	YSL-2.1/2-SW2-15/16	*529594	4.675	5.000	1.654	5.000	7.283	23.70
3	YSL-2.1/2-SW3	*529617	4.774	5.000	1.732	5.000	7.283	24.10
3 1/8	YSL-2.1/2-SW3-1/8	*529648	4.921	5.000	1.732	5.000	7.283	24.60
3 1/4	YSL-2.1/2-SW3-1/4	*529662	4.999	5.000	1.890	5.394	7.677	26.30
3 3/8	YSL-2.1/2-SW3-3/8	*529693	5.197	5.000	1.969	5.276	7.677	28.70
3 1/2	YSL-2.1/2-SW3-1/2	*529716	5.354	5.000	2.047	5.315	7.677	29.50
3 5/8	YSL-2.1/2-SW3-5/8	*529730	5.394	5.000	2.047	5.315	7.677	30.40
3 3/4	YSL-2.1/2-SW3-3/4	*529785	5.591	5.000	2.126	5.472	7.835	31.80
3 7/8	YSL-2.1/2-SW3-7/8	*529808	5.787	5.000	2.205	5.315	7.677	32.40
4	YSL-2.1/2-SW4	*529815	5.827	5.000	2.205	5.315	7.677	33.20
4 1/8	YSL-2.1/2-SW4-1/8	*529846	6.063	5.000	2.362	5.709	8.071	35.90
4 1/4	YSL-2.1/2-SW4-1/4	*529860	6.299	5.000	2.520	5.866	8.228	38.20
4 3/8	YSL-2.1/2-SW4-3/8	*529891	6.379	5.000	2.520	5.866	8.228	39.10
4 1/2	YSL-2.1/2-SW4-1/2	*529907	6.496	5.000	2.638	5.906	8.268	39.00
4 5/8	YSL-2.1/2-SW4-5/8	*529938	6.536	5.000	2.638	5.906	8.268	40.20
4 7/8	YSL-2.1/2-SW4-7/8	*529952	7.047	5.000	2.874	6.181	8.465	45.30
5	YSL-2.1/2-SW5	*529976	7.163	5.000	2.992	6.181	8.465	47.20
5 1/8	YSL-2.1/2-SW5-1/8	*529990	7.203	5.000	2.992	6.181	8.465	48.30
5 1/4	YSL-2.1/2-SW5-1/4	*530002	7.203	5.000	2.992	6.181	8.465	48.30
5 3/8	YSL-2.1/2-SW5-3/8	*530033	7.609	5.984	3.110	6.378	8.661	57.20
5 1/2	YSL-2.1/2-SW5-1/2	*530040	7.717	5.984	3.228	6.575	8.858	57.70
5 5/8	YSL-2.1/2-SW5-5/8	*530071	7.757	5.984	3.228	6.575	8.858	58.50
5 3/4	YSL-2.1/2-SW5-3/4	*530095	8.081	5.984	3.346	6.772	9.055	64.10
6 1/8	YSL-2.1/2-SW6-1/8	*530125	9.016	6.890	3.780	7.165	9.449	82.60
6 1/2	YSL-2.1/2-SW6-1/2	*530149	9.016	6.890	3.780	7.165	9.449	82.60
6 7/8	YSL-2.1/2-SW6-7/8	*530163	9.528	6.890	3.397	7.165	9.449	89.90
7	YSL-2.1/2-SW7	*530187	9.685	6.890	4.055	7.362	9.646	91.60
7 1/4	YSL-2.1/2-SW7-1/4	*530200	10.000	6.890	4.173	7.559	9.843	100.30
7 1/2	YSL-2.1/2-SW7-1/2	*530224	10.276	6.890	4.291	7.559	9.843	103.20
7 5/8	YSL-2.1/2-SW7-5/8	*530248	10.433	6.890	4.409	7.835	10.118	106.20
7 3/4	YSL-2.1/2-SW7-3/4	*530262	10.433	6.890	4.409	7.835	10.118	106.20
7 7/8	YSL-2.1/2-SW7-7/8	*530286	10.748	6.890	4.528	7.953	10.236	114.20
8	YSL-2.1/2-SW8	*530309	10.798	6.890	4.528	7.953	10.236	115.30
8 1/8	YSL-2.1/2-SW8-1/8	*530316	11.220	6.890	4.724	7.953	10.236	120.40
8 1/4	YSL-2.1/2-SW8-1/4	*530330	11.220	6.890	4.724	7.953	10.236	120.40
8 3/8	YSL-2.1/2-SW8-3/8	*530378	11.225	6.890	4.724	7.953	10.236	121.30
8 1/2	YSL-2.1/2-SW8-1/2	*530408	11.496	6.890	4.843	8.346	10.630	130.70
9	YSL-2.1/2-SW9	*530415	12.029	6.890	5.118	8.661	10.630	138.50
9 1/4	YSL-2.1/2-SW9-1/4	*530446	12.029	6.890	5.118	8.661	10.630	138.50

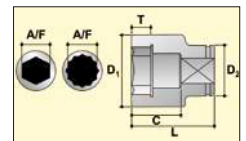

Products



**Hoisting Equipment**

- Ratchet lever hoists
- Hand chain hoists
- Corrosion & Explosion protection
- Trolleys & Trolley clamps
- Electric & Pneumatic chain hoists
- Chains & Accessories
- Manual winches
- Cable puller & Accessories
- Electric & Pneumatic winches
- Rack & Pinion jacks



**Tigrip® Load Hoisting Tackle**

- Grabs & Clamps
- Permanent load lifting magnets
- Lifting lugs & C-hooks
- Barrel grabs & Crate grabs
- Load hoisting tackle for underground construction
- Clamps & Tine hooks
- Spreader beams
- Crane forks

**Tigrip® Crane Weighers**

- Crane weighers
- Load indicator



**Textile Lifting Slings**

- Round slings
- Round sling assembly
- Webbing slings
- Accessories

**Lashing Systems**

- Lashings
- Special lashings
- Accessories



**Crane systems**

- Wall-mounted jib crane
- Floor-mounted jib crane
- Moveable gantry crane
- Light crane system

**Power supply**



**Personal Protective Equipment**

- Harnesses
- Lanyards
- Work positioning devices
- Fall arrest blocks
- Accessories
- Descending and hoisting devices
- Tripod & five leg anchor point
- Rescue winches
- Rope access
- Anchor points
- Fall arrester with rope grab
- Height safety kits





### Hydraulic Jacks & Tools

- Hydraulic cylinders, single-acting
- Hydraulic cylinders, double-acting
- Hydraulic pumps 700 bar & up to 2000 bar
- Foot pump 700 bar
- Electric & Pneumatic motorpumps
- Electric hydraulic power packs
- Hydraulic valves & Accessories
- Hydraulic puller & Jacks
- Hydraulic tools
- Test rig for hoisting equipment
- Workshop presses



### Workshop Equipment

- Jacks
- Workshop presses
- Service jack
- Supporting stand
- Repair sets
- Workshop cranes



### Spring Balancers

- Spring tensioners
- Spring balancers



### Bolting Technology

- Hydraulic torque wrenches
- Pneumatic torque wrenches
- Hydraulic nut splitters
- Flange spreaders
- Hydraulic lifting & spreading wedges
- Torque multipliers
- Torque wrenches
- Hydraulic bolt tensioners
- Impact sockets



### Material Handling Equipment

- Hand pallet trucks
- Hand pallet trucks with weighing system
- Scissor pallet trucks
- Pallet lift trucks
- Manual drive stackers
- Electric pedestrian stackers
- Elevating platforms



### Load Moving Systems



Germany

**COLUMBUS McKINNON  
Industrial Products GmbH\***  
Am Lindenkamp 31  
42549 Velbert  
Phone: 00 49 (0) 20 51/600-0  
Fax: 00 49 (0) 20 51/600-127  
Web Site: www.cmco.eu, www.yale.de  
E-mail: info.velbert@cmco.eu

**COLUMBUS McKINNON  
Engineered Products GmbH\***  
Am Silberpark 2-8  
86438 Kissing  
Phone: 00 49 (0) 8233 2121-800  
Fax: 00 49 (0) 8233 2121-805  
Web Site: www.cmco.eu, www.pfaff-silberblau.com  
E-Mail: info.kissing@cmco.eu

China

**Hangzhou LILA  
Lifting and Lashing Co. Ltd.\***  
No. 3350 Nanhuan Road, Zhijiang Industrial Park  
Hangzhou Hi-tech Zone  
Zhejiang Province  
Postcode 310053  
Phone: 00 86 21 38 82 06 20  
Fax: 00 86 10 85 23 63 87  
Web Site: www.cmco-cn.com  
E-mail: inquiryasia@cmworks.com

**COLUMBUS McKINNON (Hangzhou)\*  
Industrial Products Co. Ltd.**  
No. 100 Luofeng Road  
Yiqiao, Xiaoshan District  
Hangzhou, Zhejiang Province  
Postcode 311256  
Phone: 00 86 21 38 82 06 20  
Fax: 00 86 10 85 23 63 87  
Web Site: www.cmco-cn.com  
E-mail: inquiryasia@cmworks.com

France

**COLUMBUS McKINNON France SABL\***  
Zone Industrielle des Forges  
18108 Vierzon Cedex  
Phone: 00 33 (0) 248/71 85 70  
Fax: 00 33 (0) 248/75 30 55  
Web Site: www.cmco-france.com  
E-mail: sales.fr@cmco.eu

United Kingdom

**COLUMBUS McKINNON Corporation Ltd.**  
Knutsford Way, Sealand Industrial Estate  
Chester CH1 4NZ  
Phone: 00 44 (0) 1244 375375  
Fax: 00 44 (0) 1244 377403  
Web Site: www.cmco.eu  
E-mail: sales.uk@cmco.eu

Italy

**COLUMBUS McKINNON Italia S.r.l.**  
Via P. Picasso, 32  
20025 Legnano (MI)  
Phone: 00 39 (0) 331/57 63 29  
Fax: 00 39 (0) 331/46 82 62  
Web Site: www.cmco.eu  
E-mail: sales.it@cmco.eu

Netherlands

**COLUMBUS McKINNON Benelux B.V.\***  
Grotenoord 30  
3341 LT Hendrik Ido Ambacht  
Phone: 00 31 (0) 78/6 82 59 67  
Fax: 00 31 (0) 78/6 82 59 74  
Web Site: www.cmco.eu  
E-mail: sales.nl@cmco.eu

Northern Ireland & Republic of Ireland  
**COLUMBUS McKINNON Corporation Ltd.**

1A Ferguson Centre  
57-59 Manse Road  
Newtownabbey BT36 6RW  
Northern Ireland  
Phone: 00 44 (0) 2890 840697  
Fax: 00 44 (0) 2890 343673  
Web Site: www.cmco.eu  
E-mail: sales.ni@cmco.eu

Austria

**COLUMBUS McKINNON Austria GmbH\***  
Gewerbepark, Wiener Straße 132a  
2511 Pfaffstätten  
Phone: 00 43 (0) 22 52/4 60 66-0  
Fax: 00 43 (0) 22 52/4 60 66-22  
Web Site: www.cmco.at  
E-mail: sales.at@cmco.eu

Poland

**COLUMBUS McKINNON Polska Sp. z o.o.**  
ul. Owsiana 14  
62-064 PLEWISKA  
Phone: 00 48 (0) 61 6 56 66 22  
Fax: 00 48 (0) 61 6 56 66 88  
Web Site: www.pfaff.info.pl  
E-Mail: kontakt@pfaff-silberblau.de

Russia

**COLUMBUS McKINNON Russia LLC**  
ul. Marshala Govorova 35/2  
198095 St. Petersburg  
Phone: 007 (812) 322 68 38  
Fax: 007 (812) 322 68 38  
Web Site: www.yale.de  
E-mail: info@yalekran.ru

Switzerland

**COLUMBUS McKINNON Switzerland AG**  
Dällikerstraße 25  
8107 Buchs ZH  
Phone: 00 41 (0) 44 8 51 55 77  
Fax: 00 41 (0) 44 8 51 55 88  
Web Site: www.cmco.ch  
E-mail: info.buchs@cmco.eu

Spain & Portugal

**COLUMBUS McKINNON Ibérica S.L.U.**  
Ctra. de la Esclusa, 21 acc. A  
41011 Sevilla  
Phone: 00 34 954 29 89 40  
Fax: 00 34 954 29 89 42  
Web Site: www.yaleiberica.com  
E-mail: informacion@cmco.eu

South Africa

**CMCO Material Handling (Pty) Ltd.\***  
P.O. Box 15557  
Westmead, 3608  
Phone: 00 27 (0) 31/700 43 88  
Fax: 00 27 (0) 31/700 45 12  
Web Site: www.yale.co.za  
E-mail: sales@cmcosa.co.za

**Yale Engineering Products (Pty) Ltd.**

12 Laser Park Square, 34 Zeiss Rd.  
Laser Park Industrial Area, Honeydew  
Phone: 00 27 (0) 11/794 29 10  
Fax: 00 27 (0) 11/794 35 60  
Web Site: www.yalejhb.co.za  
E-mail: info@yalejhb.co.za

**Yale Lifting Solutions (Pty) Ltd.**

P.O. Box 592  
Magaliesburg, 1791  
Phone: 00 27 (0) 14/577 26 07  
Fax: 00 27 (0) 14/577 35 34  
Web Site: www.yale.co.za  
E-mail: sales@yalelift.co.za

Thailand

**Yale Industrial Products  
Asia (Thailand) Co. Ltd.**  
54 BB.Building, Room No. 1510, 15th Floor,  
Sukhumvit 21 (Asoke) Road, Klongtoey Nua  
Wattana, Bangkok 10110  
Phone: 00 66 (0) 26 64 03 00  
Fax: 00 66 (0) 26 64 03 01  
Web Site: www.yale-thailand.com

Turkey

**COLUMBUS McKINNON  
Kaldırma Ekip. San. ve Tic. Ltd. Şti.**  
Davutpaşa Caddesi Emintaş  
Davutpaşa Matbaacılar Sitesi No. 103/233-234  
34010 Topkapı-istanbul  
Phone: 00 90 (212) 210 7 555  
Fax: 00 90 (212) 220 7 505  
Web Site: www.cmco.eu  
E-mail: info.turkey@cmco.eu

Hungary

**COLUMBUS McKINNON Hungary Kft.**  
Vásárhelyi út 5. VI ép  
8000 Székesfehérvár  
Phone: 00 36 (22) 546-720  
Fax: 00 36 (22) 546-721  
Web Site: www.yale.de  
E-mail: info@cmco-hungary.com

United Arab Emirates

**COLUMBUS McKINNON  
Industrial Products ME FZE**  
Warehouse No. FZSBD01  
P.O. Box 261013  
Jebel Ali  
Dubai, U.A.E.  
Phone: 00 971 4 880 7772  
Fax: 00 971 4 880 7773  
Web Site: www.cmco.eu  
E-mail: sales.uae@cmco.eu